

PREQUALIFICATION

Stop
Water Leakage

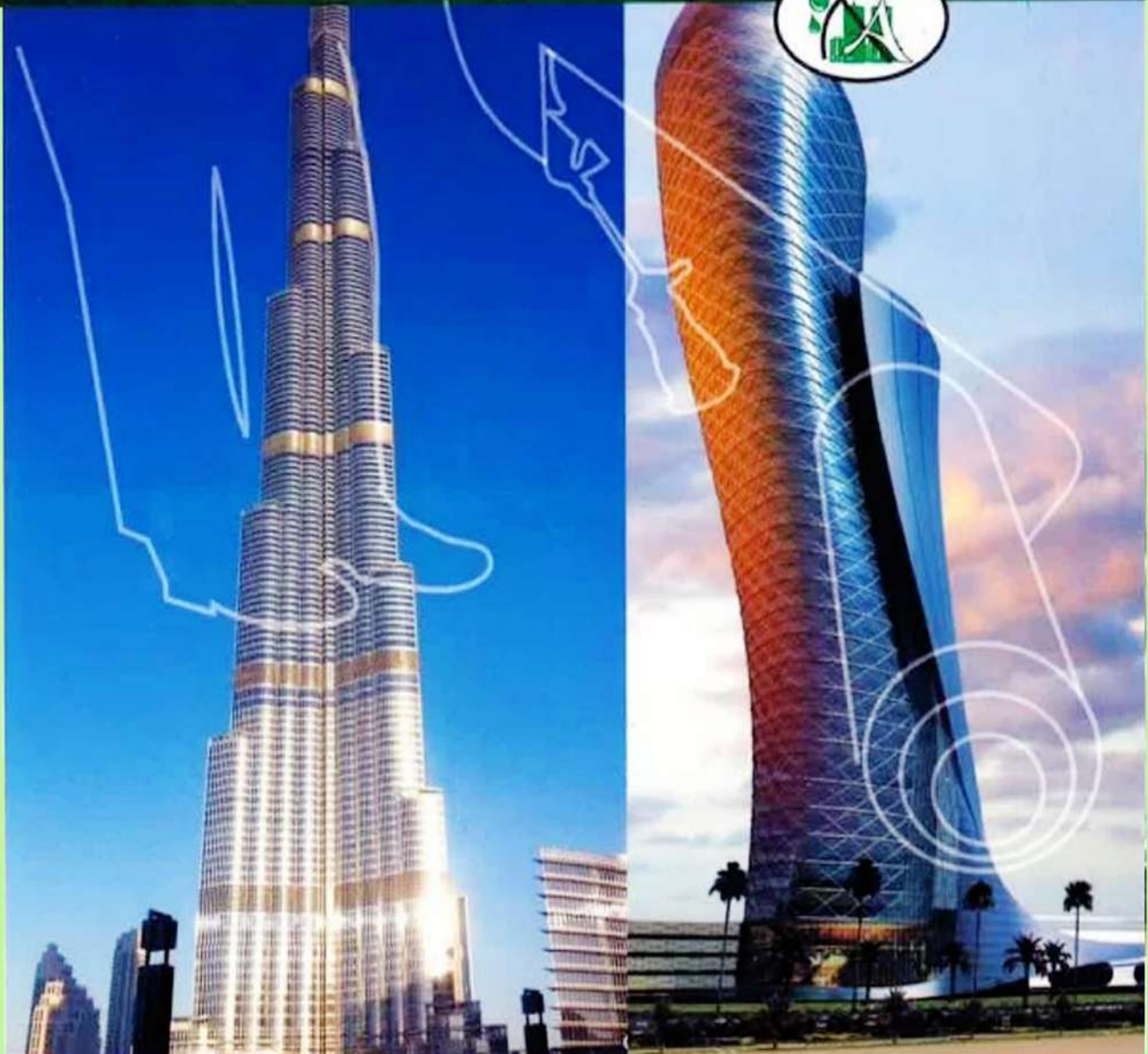

Tahir Amin INSULATION CONT. LLC

+971 65469744 +971 50 9677832
info@taic.ae, insulation008@gmail.com

www.taic.ae @taicllc2008
completewaterproofingsolution



INDEX

Content	Page No.
Title Page	1
Index	2
Company Profile (English)	3
Company Profile (Arabic)	5
General Information	6
Trade License	7
Vat Registration Certificate	8
Clients List	9
Project List	11
Approvals	15
Warranty Letter Specimen	54
Conventional Roofing System	58
Light Weight Foam Concrete	59
Liquid Applied Waterproofing	67
GRP Lining	68
Crack Treatment by Injection	76
Combo Roofing System	79
Expansion Joint Wide Range	82
Maintenance Services	109



COMPANY PROFILE

INTRODUCTION:

We M/s. **Tahir Amin Insulation Contracting LLC** is the core Sub-Contractor in the field of **Waterproofing / GRP lining for water tanks / Cracks treatment by Injections / Expansion Joint/Foam Concrete etc.** since Decades in UAE. Our Company offers the perfect Waterproofing solution to prevent penetration of water and chemical substances in any form. The whole waterproofing range of products are used to meet the requirements of the most demanding Industrial and Domestic waterproofing applications and guaranteed long-lasting results across all application areas such as **Roof, Balconies, Terraces, Foundations, Basements, Swimming Pools, Water Tanks, Bathrooms & Manholes** etc.

OUR MAIN SERVICES ARE:

- ▶ Civil works and Buildings Maintenance
- ▶ Expansion Joint
- ▶ GRP Lining for Water Tanks
- ▶ Crack Treatment by injection
- ▶ PVC Membrane System
- ▶ Combo System
- ▶ Epoxy flooring (car parking's, micro cement, metallic etc.)
- ▶ External insulation finishing system (EIFS) to reduce the electric consumption up to 45% and to keep the home cool Up to 45% more (Green Buildings System)
- ▶ Light Weight Foam Concrete
- ▶ Bitumen Membrane System

We have successfully developed a large pool of high competent, trained technical workforce, who can handle complex demand of various situations. Our association with **Henkel Polybit, Derma bit, Betagum, Awazeel, Naue, Naue Sealing** etc. a leading manufacturer of water proofing products, is cooperating with us to diagnose & handles special cases and accordingly selects the effective treatment & solution.

We assure that only reputed & high quality material is utilized in our projects that meet all prescribed technical specifications.

Our skilled, qualified & highly experienced team ensures the high standards & time schedule in execution of all of our projects.

SOME OF OUR CUSTOMERS TO WHOM WE GIVEN OUR BEST SERVICES ARE:

- ▶ Sharjah Municipality Environmental project, waterproofing Area = 275450 m2
- ▶ Ghantoot Contracting Company
- ▶ Meydan Group LLC
- ▶ Shapoorji Pallonji Mideast LLC
- ▶ Arabtec Construction
- ▶ DP World
- ▶ Neptune Gen. Cont. LLC
- ▶ Tiger Cont. LLC
- ▶ Linkage Developers
- ▶ Dubai Municipality
- ▶ BW Gulf Engineering Consultants & many more



Contractors in: **Water Proofing** (Hot, Cold & Acoustic), Buildings, Tunnels, Bridges Off Shores, Swerage System, Base Lining (Environmental & Land Fill Projects) & All Allied Civil Applications

OUR MISSION:

Our mission is to preserve high standard of quality services that meets customer need and requirements with maximum satisfaction and to develop long-term business relationship.

Hope the above introduction meets your standard and requirements; we are requesting you to register our company in your esteemed organization for waterproofing works for your future projects.

Kindly feel free to contact us at any time. We now look forward to your support and patronage and on our part we shall strive to give our services which ranks among the best.

You can send us inquiries by phone, fax or email, to our give below address.

Eng. Tahir Amin
General Manager
+971 50 9677832



نبذة عن الشركة

مقدمة:

نحن احدى الشركات الرائدة في مجال أعمال العزل ضد الماء/ بطانات جي آر بي لخزانات المياه /معالجة الشقوق بواسطة الحقن /الخرسانة الرغوية... الخ ، وقد تمكنا من تطوير عدد كبير من العمال المؤهلين تأهيلا عاليا والمدربين تدريبيا جيدا و القادرين على توفير وتحقيق الطلبات المعقدة المرتبطة بمختلف الحالات. كما ان لدينا علاقات عمل وتعاملات مع شركات رائدة في مجال تصنيع منتجات العزل ضد الماء مثل هينكيل بولي بيت، ديرمابيت، بيتاغوم، عوازل، ناوى، ناوى سيلينغ . الخ ، وهناك تعاون بيننا لتشخيص ومعالجة من الحالات الخاصة ووفقا لذلك نقوم باختيار أنواع المعالجة الفاعلة والحلول الجيدة . كما ان شركة طاهر أمين لمقاولات العزل ذم م متخصصة في أعمال العزل ضد الماء (الماء الحار، البارد، وعوازل الصوت) لطوابق الأساس، الجدران الشفافة، المصاطب، خزانات المياه، البنايات، الجسور، أوف شورز ، المجاري، البطانات القاعدية (المشاريع البيئية ومكبات النفايات) و كافة الهياكل الانشائية الأخرى العازلة للماء للمشاريع التجارية، السكنية والصناعية بالمنتجات العالمية الحديثة.

كذلك نؤكد أننا نستخدم فقط المواد العالية الجودة والمعروفة في تنفيذ مشاريعنا بالتطابق مع كافة المواصفات الفنية المطلوبة.

كما يضمن فريق العمال التابع لنا الذي يتمتع بخبرات عالية والمدرب تدريبيا جيدا الوفاء بمتطلبات المواصفات القياسية فيما يتعلق بتنفيذ كافة المشاريع .

وفيما يلي بعض من عملاءنا الذين سبق وأن قدمنا لهم خدماتنا:

- 1 مشروع بلدية الشارقة للبيئة ، بلغت المساحة العازلة ضد الماء = 275450 متر مربع
- 2 شركة غننور للمقاولات
- 3 شركة ماجد الهلال للمقاولات - ذ.م.م
- 4 شركة نبتون للمقاولات العامة - ذ.م.م
- 5 شركة تايجر للمقاولات - ذ.م.م
- 6 شركة يوروستار للانشاءات - ذ م م
- 7 شركة لينكيج لتطوير
- 8 المجموعة الهندسية المتكاملة
- 9 شركة بي دبليو جلف للاستشارات الهندسيه

بالاضافة الى العديد من العملاء الآخرين.

نأمل أن تكون المقدمة الواردة أعلاه مليية لتطلعاتكم وكافية لتحقيق متطلباتكم ، وبهذا نرجو منكم تسجيل شركتنا لدى شركتكم العامرة ومنحنا الفرصة لتنفيذ أعمال العزل ضد الماء ضمن مشاريعكم المستقبلية
يمكنكم ارسال طلباتكم لنا عبر الهاتف، الفاكس أو البريد الالكتروني ، او على العنوان التالي:

مع خالص تحياتي

عن/شركة طاهر أمين لمقاولات العزل ذ م م
المهندس/ طاهر أمين

المدير العام

موبايل: +971 509677832



GENERAL INFORMATION

01. Name of the Company : Tahir Amin Insulation Cont. LLC
02. Business Address / Location : P.O.Box : 64396, Sharjah – UAE
03. Website : www.taic.ae
04. Managing Director : Eng. Tahir Amin
05. Mobile No. : +971509677832
06. Main Business Activities : www.taic.ae
07. Trade License No. : 566008
08. TRN No. : 100320104100003
09. Email Address : insulation008@gmail.com
tahir_832@yahoo.com
info@taic.ae



Contractors in: **Water Proofing** (Hot, Cold & Acoustic), Buildings, Tunnels, Bridges Off Shores, Swerage System, Base Lining (Environmental & Land Fill Projects) & All Allied Civil Applications

GOVERNMENT OF SHARJAH
Economic Development Department



حُكُومَةُ الشَّارِقَةِ
دائرة التنمية الاقتصادية

رخصة تجارية
Trading License



566008

License Details

تفاصيل الرخصة

Issue Date	31-08-2008	تاريخ الإصدار	License No.	566008	رقم الرخصة
Expiry Date	30-08-2025	تاريخ الإنتهاء	Registration No.	19822	رقم السجل
Trade Name	TAHIR AMIN INSULATION CONT.LLC - SOLE PROPIETORSHIP				الاسم التجاري
Legal status	Individual Company L.L.C	شركة ذات مسؤولية محدودة - الشخص الواحد (ذ م م)			الشكل القانوني

License Members

أطراف الرخصة

الحصص	الصفة	رقم الهوية / الجواز	الجنسية	اسم المستثمر	رقم المستثمر
Shares	Type	ID \ Passport No	Nationality	Investor Name	Investor No
100.0 %	المالك Owner	784197331087466	باكستان Pakistan	طاهر امين وحيد بخش TAHIRAMIN WAHID BAKHSH	23328

المدير	طاهر امين وحيد بخش
أنشطة الرخصة	مقاولات فئة سادسة, عزل, التغطية والأرضيات
العنوان	الشارقة-مويبلج/الشارقة-- خلف شارع المليحة مكتب رقم 603-76 طابق رقم 6 ملك الشيخ عبدالرحمن محمد عبدالله سيف الشامسي - مركز الاريح للعمال - فرع 1
الهاتف المتحرك:	0509677832
صندوق البريد:	الشارقة 64396
البريد الالكتروني:	tahir_832@yahoo.com



User Name 1000019

رقم المستخدم

Printing Date 30-09-2024

تاريخ الطباعة

- This document is official. It doesn't need to be stamped or signed.

To view license details please visit SEDD web site: www.sedd.ae

- It is prohibited to distribute advertisements in public places and residential areas.

- هذه الوثيقة رسمية ولا تحتاج لختم أو توقيع.

للتأكد من صحة البيانات يرجى زيارة موقع الدائرة: www.sedd.ae

- يمنع توزيع الإعلانات في الأماكن العامة والأحياء السكنية.

www.sedd.ae 80080000

+971 65469744 +971 50 9677832

info@taic.ae, insulation008@gmail.com



www.taic.ae



@taicllc2008



completewaterproofingsolution



Contractors in: **Water Proofing** (Hot, Cold & Acoustic), Buildings, Tunnels, Bridges Off Shores, Swerage System, Base Lining (Environmental & Land Fill Projects) & All Allied Civil Applications

الهيئة الاتحادية للضرائب
FEDERAL TAX AUTHORITY



شهادة تسجيل لضريبة القيمة المضافة في الامارات العربية المتحدة
Certificate of Registration for Value Added Tax in the United Arab Emirates

The Federal Tax Authority certifies that the entity below is a registered person for Value Added Tax in the UAE

تشهد الهيئة الاتحادية للضرائب أن الجهة التالية مسجلة لضريبة القيمة المضافة في الامارات العربية المتحدة

Full Arabic legal name	طاهر امين لمقاولات العزل	الاسم القانوني الكامل باللغة العربية
Full English legal name	TAHIR AMIN INSULATION CONT.	الاسم القانوني الكامل باللغة الانجليزية
Registered address	Flat No G01, KEY BUSINESS, MUJARRAH-AL AROWBA STREET, sharjah, Sharjah, United Arab Emirates, 64396, +971509677832	العنوان المسجل
Tax Registration Number	100320104100003	رقم التسجيل الضريبي
Effective Registration Date	01/01/2018	تاريخ التسجيل الفعلي
First VAT Return Period	1 Jan 2018 – 30 April 2018 and quarterly thereafter	فترة أول إقرار لضريبة القيمة المضافة
VAT Return due date	28th day following the end of the VAT return period	تاريخ استحقاق إقرار ضريبة القيمة المضافة
Start and end dates of Tax periods:	1 Feb to 30 Apr, 1 May to 31 July, 1 Aug to 31 Oct, 1 Nov to 31 Jan	بداية ونهاية الفترات الضريبية

يرجى التأكد من صحة تفاصيل الشهادة. يجب إبلاغ الهيئة الاتحادية للضرائب في حال تغيير الاسس التي حصلت فيها على رقم التسجيل الضريبي الخاص بك.

Please check that the details on this certificate are correct. You must inform the Federal Tax Authority of any change on the basis of which you obtained your Tax Registration Number.



Issuing Date:

17/01/2018

تاريخ الإصدار



Contractors in: **Water Proofing** (Hot, Cold & Acoustic), Buildings, Tunnels, Bridges Off Shores, Swerage System, Base Lining (Environmental & Land Fill Projects) & All Allied Civil Applications

Some Of Our Valued Clients

 DP WORLD	 بلدية دبي DUBAI MUNICIPALITY	 ميدان meydan
 مركز دبي التجاري العالمي DUBAI WORLD TRADE CENTRE	 مجموعة بوخاطر Bukhatir Group	 Shapoorji Pallonji
 ديار DEYAAR	 GHANTOOT GROUP مجموعة غنتوت	 TIGER GROUP
 مستشفى أن أم سي رويال nmc royal hospital	 CHAPAL Built for Life Since 1968	 العربية alarabiya GROUP
 ARENCO REAL ESTATE أرنكو للعقارات	 مجموعة الزرعوني AL ZAROONI GROUP	 arabtec
 Safeer Mall	 Holiday Inn HOTELS · RESORTS	 Broadway Hotel



Contractors in: **Water Proofing** (Hot, Cold & Acoustic), Buildings, Tunnels, Bridges Off Shores, Sverage System, Base Lining (Environmental & Land Fill Projects) & All Allied Civil Applications

 ايه ار جيه للعقارات ARJ PROPERTIES	 ابوسيف ABOU SEIF BLDG. CONT. CO.	 خانصاحب KHANSAHEB FACILITIES MANAGEMENT
 BHATIA GROUP	 AMANA CONTRACTING & STEEL BUILDINGS (PVT) LTD	 علي موسى Ali Mousa - القابضة - HOLDING
 Wade Adams Constructing Excellence	 AMC Construction Ltd	 DIWAN PROPERTIES LTD
 Ajraj Buhaira Bldg. Cont. LLC	 ecc EAST COAST CONTRACTING	 DARWISH ENGINEERING EMIRATES GENERAL CONTRACTORS
 أكتكو Actco General Contracting Co., L.L.C.	 نبتون NEPTUNE للمقاولات العامة لدر	 ACC ARABIAN CONSTRUCTION CO.
 GOLDEN HOME REALTY DEVELOPMENT, INC.	 الإمارات للمقاولات العامة Emirates General Contracting	 Kele think. design. build.

And Many More



Contractors in: **Water Proofing** (Hot, Cold & Acoustic), Buildings, Tunnels, Bridges Off Shores, Swerage System, Base Lining (Environmental & Land Fill Projects) & All Allied Civil Applications

PROJECT LIST

Sr.#	Company Name	Project	Site	Type of Work
1	Shapoorji Pallonji Mideast LLC	JBR	Dubai	Waterproofing + Foam Concrete + Expansion Joint work
2	Al Safer Group	Safeer Mall Shed	Sharjah	Waterproofing work
3	Euro Star Construction LLC	Villas	Emirates Hills	GRP Lining + Foam Concrete
4	Al Fadal Contracting LLC	Masque	Ajman	Waterproofing+ Foam Concrete
5	Integral Eng. Group	2 Labor Camps	Sharjah	Waterproofing +Foam Concrete
6	Meydan Group LLC	Royal Bridge	Nad Al Sheba	Expansion Joints & Waterproofing Work
7	Bhatia Gen. Cont. Co. LLC	2B+G+10 Office Building	Dubai	Basement+ Foam Concrete +Waterproofing+ GRP Lining
8	Emirates Vally Construction	3 Building (G+4)	Sharjah	Waterproofing +Foam Concrete +GRP lining
9	Acteco Gen. Cont. Co. LLC	Ware House	Dubai	Basement+ Foam Concrete +Waterproofing
10	Jaroon Building Cont. Co. LLC	G+7 Building	Sharjah	Waterproofing + Foam Concrete +GRP lining
11	Euro Star Construction LLC	Ware House	Dubai	Water Proofing + GRP Lining + Expansion Joint work
12	Amana Steel	Ware House at Port	Sharjah	Piling Treatment + Basement
13	Gayathi Construction LLC	Ware House	Dubai	Waterproofing +Foam Concrete
14	Dewan Development	Villas	Ajman	Waterproofing +Foam Concrete +GRP lining
15	A.Y.C. Building Cont. LLC	High rise Building	Sport City Dubai	Basement+ Foam Concrete +Waterproofing
16	Alhikma Building Cont. LLC	Office & Factory(G+M)	Dubai	Complete roofing system +Wet Areas +GRP Lining + Expansion Joint work
17	Sun City Building Cont.	2, Buildings (G+6)	Ajman	Waterproofing +Foam Concrete+ GRP Lining
18	Engineering Cont. Co.	Zayed Univerisity	Dubai	Foam Concrete
19	Engineering Cont. Co.	Labor Camp	Dubai	Foam Concrete
20	Al Shofar Civil Engineering	46 Villa - Barsha	Dubai	Waterproofing +Foam Concrete +GRP lining
21	Al Shofar Civil Eng.	25 Villa	Dubai	Waterproofing +Foam Concrete
22	Emirates Contracting	2 Tower	Dubai	Waterproofing +Foam Concrete+ liquid Membrane wet area



Contractors in: **Water Proofing** (Hot, Cold & Acoustic), Buildings, Tunnels, Bridges Off Shores, Swerage System, Base Lining (Environmental & Land Fill Projects) & All Allied Civil Applications

23	Ali Mosa Contracting	400 Villa	Dubai	Waterproofing +Foam Concrete +GRP lining
24	Ali Mosa Contracting	China Town	Abu Dhabi	Waterproofing + Foam Concrete
25	AMC Contracting	Abu Dhabi Air Port	Abu Dhabi	Basement+ Foam Concrete +Waterproofing
26	Ali Ghaflee Cont.	240 Villa	Abu Dhabi	Waterproofing +Foam Concrete +GRP lining
27	Alholy Cont. Co. LLC	Labor Camp	Ajman	Complete roofing system +Wet Areas+ Foam Concrete + Expansion Joint work
28	Ali Ghaflee Cont.	112 Villa	Abu Dhabi	Waterproofing +Foam Concrete
29	Ascorp Contracting	20 Building G+3	Abu Dhabi	Waterproofing +Foam Concrete +GRP lining
30	Altharawat Contracting	47 Houses	Abu Dhabi	Foam Concrete
31	Tico Contracting	40 Villa in Binyas	Abu Dhabi	Waterproofing +Foam Concrete
32	Al Mula Contracting	230 Houses	Abu Dhabi	Waterproofing +Foam Concrete
33	East Coast Contracting	50 houses	Dubai	Waterproofing +Foam Concrete
34	BW Gulf Consultant	5 high rise Buildings	Ajman	Injection +Putty works in Slab Leaking + Expansion Joint work
35	Darwish Engineering	Al Khaleej Tower	Sharjah	Basement+Waterproofing + Foam Concrete +liquid mbrane wet area
36	Darwish Engineering	Al Gazul Tower	Sharjah	Basement+Waterproofing +Foam +liquid Membrane wet area
37	Fauzi Al Ameeri Bldng. Cont. LLC	G+5 Bldg.	Sharjah	Complete roofing system +Wet Areas+Foam Concrete
38	Sweet Home Developers	1500 Villa	Ajman	Basement Waterproofing
39	Al Dhary Group Gen. Cont. LLC	10 Labor Camps	Sharjah	GRP Lining water tanks
40	Golden Fields Construction LLC	villa+ Ware house	Dubai	Basement+ Foam Concete+Waterproofing+GRP linig
41	Majid Al Hilal Bldg. Contracting LLC	High rise Building	Sport City Dubai	Basement+ Foam Concete+Waterproofing + Expansion Joint work
42	Bonanza Contracting LLC	2,Villas in Emirates Hills	Dubai	Complete roofing system +Wet Areas+Foam Concrete
43	Pramount International Cont. LLC	Villa in Emirates Hills	Dubai	Complete roofing system +Wet Areas+Foam Concrete
44	Ajwa Building Construction LLC	(G+5P+25), Building	Sharjah	Basement Waterproofing +GRP Lining
45	Al Khayat Building	Villa in Emirates	Dubai	Foam Concrete



Contractors in: **Water Proofing** (Hot, Cold & Acoustic), Buildings, Tunnels, Bridges Off Shores, Swerage System, Base Lining (Environmental & Land Fill Projects) & All Allied Civil Applications

46	City Diamond Cont. LLC.	Villa in Emirates Hills	Dubai	Foam Concrete +Waterproofing+GRP Lining
47	Baz Al Mouhairi Cont.	Villa in Emirates Hills	Dubai	Waterproofing+Grp Lining+Foam Concrete
48	Arabian German Bldng Cont. LLC	Ware house	Dubai	Waterproofing + Foam Concrete
49	Deco Emirates Bldng. Cont. LLC	H.R. Bldng in Grdn. Scty.	Dubai	Water Proofing
50	AL Rasekh Gen. Cont. Co.	2, Labour Camps	Sharjah	Waterproofing + Foam Concrete
51	AL Rasekh Gen. Cont. Co.	Ware house	Sharjah	Waterproofing + Foam Concrete
52	Linkage Developers	4, G+4 Buildings	Ajman	Complete roofing system +Wet Areas+Foam Concrete + Expansion Joint work
53	FWO Abu Dhabi	Army Camp	Abu Dhabi	Waterproofing +GRP Lining +Expansion Joint
54	Al Khamas Bldng Cont. LLC	Bldng.	Dubai	Foam Concrete +Waterproofing+Grp Lining
55	Al Thabat Bldng Cont. LLC	Ware house	Sharjah	Waterproofing+Foam Concrete
56	Abraj Al Buhairah Bldng. Cont. LLC	2, G+4 Buldngs	Sharjah	Basement waterproofing+GRPL+Liquid for wet areas
57	Hadeel Bldng. Cont.	Bldng.	Sharjah	Waterproofing +GRP Lining
58	Quality House Bldng. Cont. LLC	Labour Camp	Sharjah	Waterproofing+Foam Concrete
59	Jose Cont. LLC	Villas	Sharjah	Waterproofing
60	Triplanet Cont. LLC	High rise Building	Sport City Dubai	Basement Waterproofing
61	Ramada Hotel Ajman	3, High rise Building	Ajman	Re waterproofing for Roof areas
62	Sam Sam Bldng Cont. Co. LLC	Labour Camp	Sharjah	Waterproofing +Foam Concrete
63	Perfect Bldng. Contractor LLC	Villa	Sharjah	Complete roofing system +Wet Areas+Foam Concrete
64	Al Mawaqee Bldng. Cont. Co. LLC	G+6, Bldng	Sharjah	Water Proofing
65	Chapal Developers	9 High rise Towers	Ajman	Basement+ Foam Concete+Waterproofing+GRP linig + Expansion Joint work
66	Golden home Construction Co. LLC	2,Labour Camps	Sharjah	Waterproofing +Foam Concrete



Contractors in: **Water Proofing** (Hot, Cold & Acoustic), Buildings, Tunnels, Bridges Off Shores, Swerage System, Base Lining (Environmental & Land Fill Projects) & All Allied Civil Applications

67	Al Samir International Cont. Co. LLC	Labor Camp	Sharjah	Waterproofing +Foam Concrete
68	Al Sundus Bldng. Cont. LLC	Villa	Sharjah	Waterproofing +Foam Concrete
69	Abu seif Building Cont. LLC	9 High rise Towers	Ajman	Basement+ Foam Concrete+ Waterproofing + GRP lining +Expansion Joint work
70	Elite Bldng Cont. Co. LLC	2, G+6 Buildings	Sharjah	Waterproofing +Foam Concrete +GRPL
71	Elite Bldng Cont. Co. LLC	3, Labor Camp	Sharjah	Waterproofing +Foam Concrete +GRPL
72	Tiger Cont. LLC	Sheds + Bldg. + Pump houses	Sharjah	Water Proofing + Expansion joint work
73	Gulf Tower Cont. LLC	Bldg.	Sharjah	Waterproofing +Foam Concrete
74	Karam Construction LLC	High rise Building	Sharjah	Waterproofing
75	Wahat Al Omer Bldng. Cont. LLC	2, Villas	Sharjah	Complete roofing system +Wet Areas +Foam Concrete
76	Ghantoot Contracting LLC	88 Villas	Dubai	Waterproofing +Foam Concrete +GRP + Expansion joint work
77	Integral Engg. Group	Villas	Sharjah	Foam Concrete + Waterproofing + GRP Lining
78	Al Rai Al Saheeh Bldng. Cont. LLC	Villa	Sharjah	Waterproofing + GRPL
80	Town Centre	G+1	Jumairah Dubai	Roof Waterproofing + Expansion joint work
81	Neptune General Contracting	G+6P+36	Sharjah	Waterproofing + GRPL + Parking
82	Arab Tec	DM Project, Al Awaer Pumping Station Dubai	Dubai	Roof Waterproofing
83	Merccato Mall	G+1	Jumairah Dubai	Roof Waterproofing + Expansion Joint work





Contractors in: **Water Proofing** (Hot, Cold & Acoustic), Buildings, Tunnels, Bridges Off Shores, Swerage System, Base Lining (Environmental & Land Fill Projects) & All Allied Civil Applications

APPROVALS

ARIF & BINTOAK Project No. 1511		DIST. <input type="checkbox"/> FOR APPROVAL <input type="checkbox"/> FOR ACTION		Benoj		Material Approval Request	
PD	Benoj	Benoj		Benoj			
RE							
SE							
EE	Project Title : JBR Enhancement (The Walk & Podium)	Lead Consultant : Benoj		The Engineer : Arif & Bintook		Contractor : Shapoorji Pallonji Mideast LLC	
ME	The Employer : Estithmar Reality FZ-LLC						
QS	Submission Ref No	Revision		Date of Submittal			
Insp (MEP)	SPAL-BNY-1511-JBR-MAT-376	00		19-Sep-2015			
Insp (Civil)							
DC	Material Discipline:						
COMMENTS:	Architectural <input type="checkbox"/>	Civil <input checked="" type="checkbox"/>	Mechanical <input type="checkbox"/>	Electrical <input type="checkbox"/>	Plumbing <input type="checkbox"/>	Landscaping <input type="checkbox"/>	Other <input type="checkbox"/>
Material Title :		Specification Ref No:		Drawing Ref No:		20150919	
Water Borne Intumescent Acrylic Sealant		AB APPROVED WITH COMMENTS Date: 20150919				RECEIVED 20 SEP 2015	
Supplier/Subcontractor name:		Address:		Subcontractors Ref No:			
M/s. Tahir Amin Insulation Cont.Co		Dubai U.A.E					
No	Description - Specified	Description - Proposed					
1		FOR INTERFACE BUILDING AND NEW RETAIL					
Attachments:	1- Product data/ Catalog <input type="checkbox"/>	Yes	2- Specification <input type="checkbox"/>	Yes	3- Samples <input type="checkbox"/>	Yes	4- Others <input type="checkbox"/>
The Contractor has reviewed the submission prior to submission to The Engineer				Received By The Engineer:			
Reviewed by Contractor		Approved for Submittal by Project Director		Signature:		Signature:	
Signature: <i>[Signature]</i>		Signature: <i>[Signature]</i>		Date: 19 SEP 2015		Date: 19 SEP 2015	
Date:		Date:		Date:		Date:	
For Use By Lead Consultant/ the Engineer:							
Comments:							
No objection subject to:-							
- Fully compliance with contract documents							
- Applying as per manufacturer recommendations							
Approval Status							
A Approved <input type="checkbox"/>		B Approved as Noted <input checked="" type="checkbox"/>		C Review & Resubmit <input type="checkbox"/>		D Rejected <input type="checkbox"/>	
E Other <input type="checkbox"/>							
The Engineer's Signature		Lead Consultant Signature					
For and on behalf of Arif & Bintook		For and on behalf of Cracknell (As applicable)		For and on behalf of Benoj			
Date: 20.09.15		Date:		Date:			
Note: Corrections or comments made relative to submittals during this review do not relieve the contractor from compliance with the requirements of the drawings and specifications. This check is only for review of general conformance with the design concept of the project and general compliance with the information given in the contract documents. The contractor is responsible for confirming and correlating all quantities and dimensions selecting fabrication processes and techniques of construction, coordinating his work with that of other trades, and performing his work in a safe and satisfactory manner.							
CC: Employer: 1 Copy (With All Attachments) <input type="checkbox"/> (Cover Page only) <input type="checkbox"/>							
Received By (contractor) - One copy with Attachment		Signature:		Date:			



Contractors in: **Water Proofing** (Hot, Cold & Acoustic), Buildings, Tunnels, Bridges Off Shores, Swerage System, Base Lining (Environmental & Land Fill Projects) & All Allied Civil Applications

SUB-CONTRACTOR / SUPPLIER APPROVAL FORM			
 موانئ دبي العالمية DP WORLD		BC	
<i>Business Planning & Project Development</i>			
CLIENT	SUBMITTAL NO. SC - C46HP / 022		
PROJECT	: M/S. DP World, PDD		
MAIN CONTRACTOR	: C46HP-New land Development Works (Africa Region) at HP		
	: AL HIKMA BUILDING CONTRACTING LLC		
NAME OF SUB-CONTRACTOR/SUPPLIER	TAHIR AMIN INSULATION CONT.		
NAME OF MATERIAL	WATER PROOFING		
SPEC/BOQ/DWG. REF (Enclose Copy)	PREQUALIFICATION (1 copy)		
SAMPLE SUBMITTED	LITERATURE SUBMITTED:		
FORM SUBMITTED BY MAIN CONTRACTOR	MOHD. ABD ALLAN Name	 Signature	4/7/2013 Date
FORM RECEIVED BY DPW	Name	Signature	Date
DPW COMMENTS	<input type="checkbox"/> Approved <input checked="" type="checkbox"/> Approved with comments: Approved by the main contractor Responsibility to assure the Quality of work done by any subcontractor. <input type="checkbox"/> Submittals is incomplete. The following is required: <input type="checkbox"/> Rejected, because:		
DPW REPRESENTATIVE APPROVAL			DATE: 9/7/13
CLIENT'S APPROVAL			DATE:
DPW HEAD OFFICE APPROVAL			DATE:
FORM RECEIVED BY MAIN CONTRACTOR	Name	Signature	Date





Certificate of Conformity

To,
Sharjah Electricity and water Authority

Date: 03.05.2018
Ref: TAI/SHJ/EBC/SS/180418/082aa

Hereby, it is certified that the products listed below have been manufactured and inspected in accordance with the conditions and requirements of the contract/ Purchase order and unless otherwise stated, confirm in all respects with the specified requirements.

Project Details:

Client	Haygaz Antranik Tahmassian Savara
Project	Proposed (G+ M) Offices+(G+) Labor Acc.+Subs &Elec.+Boundry wall plot # 1248, Al Arquob Sharjah UAE
Location	1248, Al Arquob, Sharjah. UAE
Consultant	International Eng.
Main Contractor	Emdad Building Contracting LLC





Contractors in: **Water Proofing** (Hot, Cold & Acoustic), Buildings, Tunnels, Bridges Off Shores, Swerage System, Base Lining (Environmental & Land Fill Projects) & All Allied Civil Applications

 Client MAZAYA AWM TO LEAD	 National Engineering Bureau Architecture & Engineering Consultancy	Main Contractor Kele think. design. build.
-------------------------------------	---	---

APPROVAL OF SAMPLES / MATERIALS

Project:	22 Buildings, LIWAN Project	Project Code:	22- Liwan
Plot No/Location:	R- 46, R-52, R-53	Rev. No:	00 R-000-AM-CS-208
Main Contractor:	Kele Contracting LLC	Date:	
MATERIAL TYPE		NEB NATIONAL ENGINEERING BUREAU	
<input checked="" type="checkbox"/> Architectural	<input type="checkbox"/> Electrical	<input type="checkbox"/> Mechanical	ACTION ID
<input type="checkbox"/> Firefighting	<input type="checkbox"/> Plumbing	<input type="checkbox"/> Structural	PRIORITY <input type="checkbox"/> Normal <input type="checkbox"/> URGENT <input type="checkbox"/> TO URGENT <input type="checkbox"/>
Sample Description	Water proofing for Wet area		
Sample Location	As mentioned on attached previous approved materials		
Encloser	Previous Approved Material ref. no. AM-CS-000-145		
NEB Approved Material	Drawing Ref:	Specification Ref:	
X			
Subcontractor/Supplier: M/s Tahir Amin Insulation Cont. Kele			
Reason for Alternation:			
Submitted By: Name: Hayman Abdelshafy	Signature	Date: 21-05-2015	RECEIVED SITE SUPERVISION 24 MAY 2015 For: _____ Time: 2-20 Sign: <i>CA</i>
Received By: Name: Iyad Tayyem	Signature:	Date:	
BELOW PORTION FOR NEB USE ONLY			
Status:	<input type="checkbox"/> Approved	<input checked="" type="checkbox"/> Approved as noted	<input type="checkbox"/> Rejected <input type="checkbox"/> Re submitted
Comments:	* ASFABIT RB. * No objection Refer to previous approval Ref No. R-000-AM-CS-121 wet areas only Hosam Elham 26.05.2015		
Name:	Signature: <i>[Signature]</i>	Date: 26/5/15	
Handover to:	Signature:	Date:	
* Clearing of above named documents is 14 days from submission date as per NEB requirements			
CLIENT'S APPROVAL AND COMMENTS			
The attached documents is applicable for wet area only not accepted for Roof water proofing system.			
Name:	Signature: <i>[Signature]</i>	Date: 27/5/15	

NEB-SF04 Rev.01
September 2012

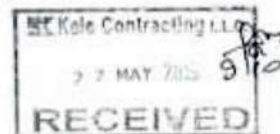



Contractors in: **Water Proofing** (Hot, Cold & Acoustic), Buildings, Tunnels, Bridges Off Shores, Swerage System, Base Lining (Environmental & Land Fill Projects) & All Allied Civil Applications



 Client	 National Engineering Bureau PLANNING & ENGINEERING CONSULTANTS	 Main Contractor Kele think. design. build.
---	--	--

APPROVAL OF MATERIALS

Project: 22 Buildings, LIWAN Project	Project Code: 22- Liwan
Plot No/Location: R-15, 73, 22, 81, 82, 3, 9, 16, 17, 46, 51, 52, 53 & 96	Ref. No: 0 R000-AM-CS-145
Date: 18 th June 2014	Main Contractor: Kele Contracting L.L.C

MATERIAL TYPE		NATIONAL ENGINEERING BUREAU	
<input type="checkbox"/> Architectural	<input type="checkbox"/> Electrical	<input type="checkbox"/> Mechanical	TO SEE: <input type="checkbox"/> ID
<input type="checkbox"/> Firefighting	<input type="checkbox"/> Plumbing	<input checked="" type="checkbox"/> Structural	ACTION: <input type="checkbox"/> Other (specify)
Material Description: " Asfabit RB " As waterproofing for wet areas		PRIORITY: NORMAL <input type="checkbox"/> URGENT <input type="checkbox"/> TOP URGENT <input type="checkbox"/>	
Note: attached Previous Approval		DATE: 19/6/14	
Material Location: Wet Areas		FILE NO: PM: 8	

ID Program Reference: No. NEB Approved Material	Drawing Ref: Same As Specified	Specification Ref: Alternative Proposed Material
yes		

Supplier / Manufacturer: Colmaf - Dubai	 Signature:	RECEIVED NEB SITE OFFICE Date: 19 Jun 2014 Time: 8:23 Sign:
Subcontractor: Siac - Dubai		
Submitted By: Name: lyad Tayyem	Signature: 	Date: 19/6/14

BELOW PORTION FOR NEB USE ONLY

Status: <input type="checkbox"/> Approved <input checked="" type="checkbox"/> Approved as noted <input type="checkbox"/> Rejected <input type="checkbox"/> Re submitted
Comments: Refers to previous approval Ref. No. R000-AM-CS-121
Hesam Eddin 19.06.2014
Name: _____ Signature: _____ Date: 19/6/14
Handover to: Name: _____ Signature: _____ Date: _____
* Clearing of above named documents is 14 days from submission date as per NEB requirements

CLIENT'S APPROVAL AND COMMENTS

Name: _____	Signature: _____	Date: _____
-------------	------------------	-------------

NEB-SF04 Rev.01
September 2012

 02 JUN 2014 16:00
RECEIVED



Contractors in: **Water Proofing** (Hot, Cold & Acoustic), Buildings, Tunnels, Bridges Off Shores, Swerage System, Base Lining (Environmental & Land Fill Projects) & All Allied Civil Applications



AMERICAN UNIVERSITY OF SHARJAH
PUBLIC RELATIONS DEPARTMENT (Security Section)
Temporary Entrance Permit

PYPRTMP/PYPRTMP

Page: 1 of 1
Date: 27-OCT-2010 11:29:48

Ref No: B081
Ref Date: 27-OCT-2010

**تصريح دخول مؤقت
إلى من يهمة الأمر**

الملكورين بالكشف المرفق: **تزوج التكرم بالسماح:**

بالدخول والمخار / السيارة رقم: **بالدخول والمخار / السيارة رقم:**

نوع السيارة / اللون: **نوع السيارة / اللون:**

إلى الحرم الجامعي وذلك من تاريخ: **2010/10/07**

رقم / اسم الموظف: **@00011179/1**

الملاحظات: **شركة طاهر امين انسوليشن**

إلى: **2010/12/31**



ولكم منا جزيل الشكر والإمتنان



يرجى اعادة التصريح للم امن بعد انتهاء عمله، وفي حقه عدم ارجاعه بله الشخص ارضه بمشراج التصريح منه
Please return this permit to the security office immediately after expiration;
otherwise, future permit will not be issued.

American University of Sharjah - P.O.Box 26666, Sharjah, United Arab Emirates - Tel: 06-5155556, Fax: 06-5182078



Contractors in: **Water Proofing** (Hot, Cold & Acoustic), Buildings, Tunnels, Bridges Off Shores, Swerage System, Base Lining (Environmental & Land Fill Projects) & All Allied Civil Applications

الإمارات العربية المتحدة - حكومة الشارقة
المدينة سنجيئة الشارقة
United Arab Emirates - Sharjah Government
SHARJAH CITY MUNICIPALITY



REQUEST NO: 18032006 SAMPLE ID: 143066 SUB SAMPLE ID: 250283
REPORT ON: Density and Compressive Strengths of Concrete Cubes
LABORATORY: CONCRETE REFERENCED BY:
CONT. / S.P. NO: 1803/2806 DATE: 04-06-10
PROJECT NAME: (1803/2006) AL MOOSA TOWER (G+2M+4P+36TYP.+HC.+HP.) COMM. BLDG.
CONSULTANT: ARENCO
CONTRACTOR: NEPTUNE CONT. CO.
LOCATION: PLOT NO. " 619 TO 623 " AL NAHIA
STRUCTURE: FOAM CRETE
CLASS OF CONCRETE: NO
DESC / SOURCE: CONCRETE CUBE
NOMINAL SIZE (mm): 150 NA. FINE REMOVED HOT PRESENT
METH. OF CONSTRUCTION: HAND TAMPING VOLUME DET. BY MEASUREMENT

SPECIMEN NO.	I
REFERENCED BY	
COND. OF SAMPLE	GOOD
AVG. LENGTH (mm)	150
AVG. WIDTH (mm)	150
AVG. HEIGHT (mm)	150
MASS (g)	3960
DENSITY (Kg/m ³)	1170
TYPE OF FAILURE	SATISFACTORY
MAX LD @ FAILURE (MPa)	111
COMP. STRENGTH (MPa)	5

طاهر امين للمقاومات العزل
TAHIR AMIN INSULATION CONT. CO.
Mob: 050 9677832, P.O. Box: 84398



AVG. COMPRESSIVE STRENGTH (N/mm²)

LABORATORY AT DATE CAST	SITE	MOIST. COND WHEN TESTED	AS RECEIVED	CURING COND.	IN WATER
ACTUAL TEST AGE (Days)	22-02-2010	DATE SAMP. REC. IN LAB	04/03/2010	DATE TESTED	04-03-2010
	10			REQD. TEST AGE (Days)	7

SAMPLE BROUGHT BY	Contractor	METHOD OF SAMPLING	BS 1881: Part 101: 1983
TEST METHOD	BS 1881: Part 114 & 116: 1983	TEST METHOD VARIATION	
REMARKS			

Tested By : NAME

This computer generated report does not require a signature



Tel: +971 6 260 8332 - Fax: +971 6 8426 651 - P.O. Box: 27 Sharjah, U.A.E.



Contractors in: **Water Proofing** (Hot, Cold & Acoustic), Buildings, Tunnels, Bridges Off Shores, Swerage System, Base Lining (Environmental & Land Fill Projects) & All Allied Civil Applications

ARENCO ABDULLAH AHMED ALMOOSA
architectural & engineering consultants



JOB # : 1869

REF # : HA/05/652

APPROVAL OF SUBCONTRACTOR

Project Name : G+2W+6P+3S STOREY BUILDING+GYM/SPRINGING POOL	
Plot No. : 72	Location : AL-NAHDA City : SHARJAH
Main Contractor : NEPTUNE GENERAL CONTRACTING	
Department : <input checked="" type="checkbox"/> Architectural <input checked="" type="checkbox"/> Structural <input type="checkbox"/> MEP	
Supplier (Proposed): M/S: Tahir Amin Insulation Cont.Co	
ARENCO Specified Subcontractor / Supplier	ALTERNATIVE Proposed Subcontractor
NIL ASPER BOK SR-1503/BH11 ROOFING SYSTEM- R1 (Roof level) FLAT ROOFING	Tahir Amin Insulation Cont. Co. For Water Proofing Work For Flat Roofing R1 - and all wet area
Manufacturer : M/S Henide	
Local Agent : M/S Henide	
Documents : M/S 3 - sets of Pre Qualification	
Reason(s) for Alternative Subcontractor / Supplier : No Specified Subcontractor.	
Submitted by : Eng. Hassan Rate	Signature: [Signature] Date: 12/12/2009
This portion is for the use of Consultant only	
Status : <input type="checkbox"/> Approved <input checked="" type="checkbox"/> Approved As Noted <input type="checkbox"/> Rejected	
Comments : 1> SHE DRAWING'S TO BE SUBMITTED ACCORDING TO ARENCO'S SPECIFICATIONS & DRAWINGS FOR REVIEW & APPROVAL 2> ALL MATERIAL SAMPLES TO BE SUBMITTED FOR ARENCO'S APPROVAL 3> ALL WARRANTY/GUARANTEE STATEMENT FOR 10YRS TO BE SUBMITTED.	
Approved by: ENGR HASSAN ALTAMER	Signature: [Signature] Date: 13/12/09

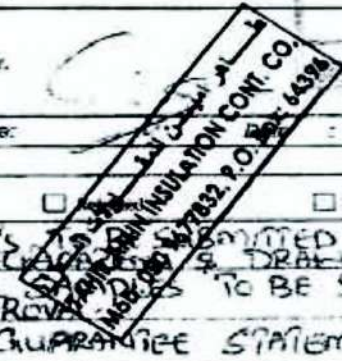
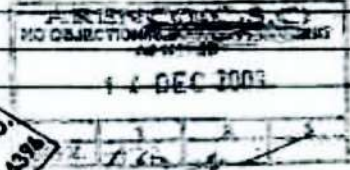

Red (3 sets)
12/12/09

4 -> ALL WORKS SHOULD BE CARRIED OUT AS PER THE MANUFACTURER SPEC. & INSTRUCTIONS AND COMPLY WITH LOCAL AUTHORITIES REGULATIONS

Received [Signature] 14/12/2009



31st May 2015

Ref: 0837/KS/TAIC/AT/L10884

TAHIR AMIN INSULATION CONT.
PO Box 64396, Sharjah, UAE
Tel. 06 564 3783
Fax. 06 564 3784

Attention : Mr. Shahzad Awan
Sales Executive

Project : Queue Point Buildings - Liwan
Location : Dubai Land, Dubai, UAE
Client : Mazaya Real Estate LLC

Subject : APPROVAL OF SAMPLES/ MATERIALS- PLOTS R- 046, 052 & 053 WATERPROOFING FOR WET AREAS

Dear Mr. Shahzad,

In reference to the subject mentioned above, please find attached Approval of Materials submittal ref. R-000-AM-CS-208 regarding Water proofing for Wet area with "**Approved as Noted**" status and commented by Consultant and Client as follows:-

Consultant:

- ASFABIT RB.
- No objection refer to previous approval (Ref. no. R000-AM-CS-121. Wet areas only).

Client:

- The attached document is applicable for wet area only.
- Not accepted for Roof water proofing system.

This is for your information and necessary action.

Yours faithfully,

Hayman Abdelshafy
Project Director

For & On Behalf of
Kele Contracting LLC

Kele Contracting LLC
P.O. Box 120780, Dubai, UAE
Tel: 04 351 8871
Fax: 04 351 8873
www.kele.ae





Contractors in: **Water Proofing** (Hot, Cold & Acoustic), Buildings, Tunnels, Bridges Off Shores, Swerage System, Base Lining (Environmental & Land Fill Projects) & All Allied Civil Applications

Client BUROOJ Properties Company		The Consultant RAMAHI - Engineering Consultancy		Main Contractor TIGER Contracting Company	
SUBMITTAL TRANSMITTAL SHEET				STS #	0135
Project Title		Construction & Maintenance of 55 Villas For Burooj Properties - MBZ City		Project Code:	
				Contract No.	
				Date:	30.06.2010
Package No.:	01100	Title	Subcontractor Prequalification	Revision #	1
Submittal Name: Taher Amin Insulation Cont .Co.					
We are sending herewith under separate cover the drawings / documents / samples listed below:					
ITEM No	DWGS. SPECS BOQ REF.	DESCRIPTION	TYPE	COPIES	REMARKS
1		Subcontractor for water proofing			Note :
		Previous approvals	OT	3	Official letter will be issued showing plots to be assigned to each subcontractor before starting water proofing works
		Method statements for:			
		..Water proofing membrane	OT	3	
		..Foam concrete	OT	3	
<small>(TYPE : SD= Shop Drawings, M= Material, S= Sample, GT= Guarantee, MD= Manufacturer's Data, CT= Certificates, TT= Test Results, OT= Other)</small>					
Subcontractor / Supplier Manufacturer:			Taher Amin Cont. Co.		
Address		Tel : 06-5643783	Fax : 06-5643784	P.O. Box : 64396 Sharjah-UAE	
We certify that the documents / materials submitted herewith have been revised in detail and are in strict conformance with the contract drawings and specifications except as otherwise stated.					
Issued by Contractor (Name) Wael			Received by Consultant (Name)		
Signature			Signature		
Date: 30.6.2010			Date:		
Design/ Supervision Consultant Review & Comments					
The subcontractor is approved following:					
1- Approved certificates from manufacturer to be submitted before executing work					
2- Resumances of the Application to be submitted					
3- letter describing the plots where the subcontractor worked to be submitted					
4- water proofing membrane still not approved. Refer to STS No 126 to achieve all comments.					
Client Acknowledgment, Approval and Comments (Only for Shop Drawing & Alternative Materials/ Vendors)					
<input type="checkbox"/> Approved <input type="checkbox"/> Approved As Noted <input type="checkbox"/> Approved as noted&Resubmit <input type="checkbox"/> Not Required <input type="checkbox"/> Not Approved					
Consultant (Name)		Client (Name)		Received by Contractor (Name)	
Signature		Signature		Signature	
Date: 12.7.2010		Date:		Date: 10-07-10	
<small>Corrections or comments made relative to submittals during this review do not relieve the contractor from compliance with the requirements of the Contract. This check is only for review of general conformance with the design concept of the project and general compliance with the information given in the contract. The contractor is responsible for confirming and correlating all quantities and dimensions, Selecting fabrication processes and techniques of construction, coordinating his work with that of other trades and performing his work in a safe and satisfactory manner.</small>					
Distribution : <input type="checkbox"/> Contractor (Original) <input type="checkbox"/> Consultant (Copy) <input type="checkbox"/> QS (Copy) <input type="checkbox"/> BUROOJ (Copy); <input type="checkbox"/> Others					



Contractors in: **Water Proofing** (Hot, Cold & Acoustic), Buildings, Tunnels, Bridges Off Shores, Swerage System, Base Lining (Environmental & Land Fill Projects) & All Allied Civil Applications



MATERIAL APPROVAL FORM		MAYFAIR RESIDENCY ON PLOT NO. BB-A06-047	
Submission No.: ECC/J325/CIV/083		Revision No.: 00	
Client	DEYAAR Development PJSC	RECEIVED Time at: 17 SEP 2009 8:20am	
Project Manager	Skeltmore Trident	ENGINEERING CONTRACTING COMPANY (ECC)	
Engineer	Arab Experts Engg. Consultants	101/7/13	
Contractor	Engineering Contracting Company (ECC)		
Project	Mayfair Residency, Plot No:BB.A06.047, Business Bay		
Sub-contractor / Supplier (if applicable)	Tahir Amin Insulation Cont. Co.		
Country of Origin / Manufacture	1. UAE 2. Saudi Arabia / Energy Projects Development 3. DOW / Arabian Chemical Company. 4. UK / Energy Projects Development 5. UAE		
Item Description	1. 10mm thick. Light Weight Concrete with dry density 700kg/m3 to form the slope. 2. 5mm thick. BETAGUM a bitumeric bituminous waterproofing membrane obtained from distilled asphalt modified with thermoplastic resins (APP,IPP). The membrane is reinforced by a non woven polyester 200gr/m2. both surfaces of the membrane are covered by a plastic film easily. 3. 50mm thick. ROOFMATE*/ROOFMATE SL* Extruded polystyrene rigid foam with skin, coloured blue throughout and 32-35kg/m3 min. density. 4. 1000 HC BETAFELT GEOTEXTILE Separation Layer. 5. 1.00mm thick. Aluminium Flashing to Upstand. Roof Floor & External Terraces (only 5mm APP Membrane) / Waterproofing Works	Requested date of Approval: 7/9/2009 Specification Clause No.: Chapter 6, Section 2, Volume III Particular Specification Clause No.: Item 06, Section 2, Volume III	
Location / Use	Roof Floor & External Terraces (only 5mm APP Membrane) / Waterproofing Works		
Date of Submission	3/9/2009		
Bill of Quantity Item No.	Item A, Bill No. 7 (Roof Waterproofing)		
Contract Drawing No.	B-604		
Shop Drawing No.	NIL		
Material Specified	Refer to attached Compliance Statement.		
Material Proposed	1. 10mm thick. Light Weight Concrete with dry density 700kg/m3 to form the slope. 2. 5mm thick. BETAGUM a bitumeric bituminous waterproofing membrane obtained from distilled asphalt modified with thermoplastic resins (APP,IPP). The membrane is reinforced by a non woven polyester 200gr/m2. both surfaces of the membrane are covered by a plastic film easily. 3. 50mm thick. ROOFMATE*/ROOFMATE SL* Extruded polystyrene rigid foam with skin, coloured blue throughout and 32-35kg/m3 min. density. 4. 1000 HC BETAFELT GEOTEXTILE Separation Layer. 5. 1.00mm thick. Aluminium Flashing to Upstand.		
Local Agent Name	Al Sindbad Building Chemicals Co.		
Technical Literature	Product Data Sheet and Catalogues Attached.		
Other attachments if any	Related Contract Drawings, BOQ, Specifications, Materials Approvals, Test Reports, List of Previous Executed Projects, Technical Data & Light Weight Concrete Mix Design.		
Samples	01 No. Sample of BETAGUM Waterproofing Membrane, 01 No. Sample of 50mm thick ROOFMATE* Extruded Polystyrene & 01 No. Sample of 1000 HC BETAFELT Separation Layer and also 1 No. complete Mock-up Sample of all materials & layers.		
Reason for Alternative	NIL		
CONTRACTOR'S ATTESTATION			
For the Contractor	Name: Ahmed Omar Signature:	Received by Engineer	Date: Signature:

Material Approval Form-Issued on 15.12.2008_Rev.03 1 of 2

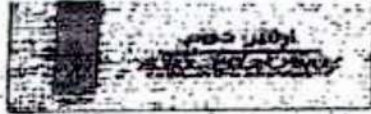

Contractors in: **Water Proofing** (Hot, Cold & Acoustic), Buildings, Tunnels, Bridges Off Shores, Swerage System, Base Lining (Environmental & Land Fill Projects) & All Allied Civil Applications

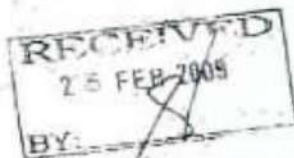

Client	Mr. Tariq Ahmed Abdulla Ahmed		
Consultant	Arch Doms Consulting Engineers		
Contractor	Al Rayan Contracting		
Project	(G+1) Villa, @ Al Basha 3 rd on plot no.-375-1141		
Sub-contractor (if applicable)	Tahir Amin Insulation Cont. Co.,		
Item Description	Foam Concrete		
Location / Use	Roof Area		
Date of Submission	25-2-2009	Requested date of Approval:	
Bill of Quantity Item No.		Specification Clause No.:	
Contract Drawing No.			
Shop Drawing No.			
Material Specified			
Material Proposed			
Local Agent Name	Advanced Insulation Mat. Industries L.L.C.		
Technical Literature	Enclosed		
Other attachments if any			
Samples			
Reason for Alternatives			
Notes			
CONTRACTOR'S SATISFACTION			
For the Contractor	 Name: Eng. Abdul Latif Signature: <i>[Signature]</i>	Received by AD	Date: Signature:
For Consultant's use:	<input type="checkbox"/> APP - Approved <input checked="" type="checkbox"/> AWC - Approved with Comments <input type="checkbox"/> RE - Rejected		
Date:			
Authorized Signature:	x Affirmed x <i>[Signature]</i> - To be used		
Comments:	 		
Corrections or comments made relative to submittals during this review do not relieve the Contractor from compliance with the contract requirement and specifications. This check is only for review of general conformance with the design concept of the project.			



Contractors in: **Water Proofing** (Hot, Cold & Acoustic), Buildings, Tunnels, Bridges Off Shores, Swerage System, Base Lining (Environmental & Land Fill Projects) & All Allied Civil Applications

CLIENT		CONSULTANT		CONTRACTOR		
Lamprell Energy Ltd. C/O P. O. BOX 2421 Dubai U.A.E. Tel: 04-5282375, Fax: 04-5282378		Halcrow International Partnership P.O. Box 673, Sharjah U.A.E. E-mail: hialc@hialc.com		شركة الجوال للمقاولات Al Jawal Contracting Company		
PROJECT : Construction of 2(Administration and Client)Office Block Facilities - Hamriyah Freezone Sharjah						
Material Submittal				<input type="checkbox"/> New Submittal <input checked="" type="checkbox"/> Re-Submittal		
Submittal No.	JC-M-043-09	Rev.	1	Date :	19/4/2009	
Project No.	24				Contractor :	Al Jawal Contracting Company L.L.C.
Consultant	HALCROW INTERNATIONAL PARTNERSHIP				Sub Contractor:	Tahir Amin Insulation Cont. Co.
Description / Technical Utitrate : Water Proof For Wet Areas With Catalogue						
Attachment: <input type="checkbox"/> Sample <input checked="" type="checkbox"/> Technical Data <input type="checkbox"/> Test Reports <input type="checkbox"/> Method of Statement <input type="checkbox"/> Others						
Area of Application/ Location : Client & Administration Building						
Specs Ref :			Manufacturer Name:			
Origin of Submittal :			Email / Tel No:			
Shop Drawing Submittal Comply with Specification <input type="checkbox"/> Yes <input type="checkbox"/> Alternative						
Details if Alternative						
Contractor AL JAWAL CONTRACTING CO.				Signature		
certified by :						
For Consultant : <input type="checkbox"/> Approved <input checked="" type="checkbox"/> Approved with Comments <input type="checkbox"/> Rejected Date forwarded to Client Date received from Client			For Client : <input type="checkbox"/> No Objection <input type="checkbox"/> Objection			
Comments :						
NO Objections Manufacturer's recommendation for handling, storage & application shall be strictly followed.						
Consultant Authorized : Signature/ Date :			Client Authorized : Signature/ Date :			
Signature/ Date : 19/04/09			Signature/ Date :			
Contractors received :						

Material & workmanship shall conform to Arch. Spec. sec. 7.29.



Contractors in: **Water Proofing** (Hot, Cold & Acoustic), Buildings, Tunnels, Bridges Off Shores, Swerage System, Base Lining (Environmental & Land Fill Projects) & All Allied Civil Applications

CONTRACTOR MATERIAL SUBMITTAL

SIS NO. [] REV. [] PROJECT ID: 422/291 DATE: 17/9/2012

PROJECT: G + 1 + 1B CLIENT: Abdullahi Mohd al shammak.

CONSULTANT: AL SHURUQ ENGINEERING CONSULTANT

CONTRACTOR: Royal Gulf Contracting / TAHIR AMIN INSULATION CONT.

Description of Item: []
S.O.C Ref: [] Spec. Ref: [] Draw Ref: []
Submittal Type: Subcontractor Material Sample Alternative
 Cost Saving

Contractor Project Manager Signature: [Signature] Received By: []
Date: 17/9/2012 Date: []

CONSULTANT COMMENTS: []

Engineer Review Comments:
* the approved system is following -
1- Foam Concrete
2- Dermabit primer modified mini 2 g/m²
3- Dermabit 4250 APP 9/m²
4- 1000 Polythene sheet
5- 5cm Extruded Polystyrene

Recommendation for Approval:
Approved
Approved as noted -> Submit sample for approval of
Resubmit
Rejected

Project Manager Review Comments:
5- Geo textile sheet
6- mortar + mosaic tiles (submit sample for approval)

* Water test to be done & checked by Consultant

Recommendation for Approval:
Approved
Approved as noted
Resubmit
Rejected

* 10 years guarantee to be submitted.

[Signature]
20/9/2012

ALSHURQ	
APPROVED	<input type="checkbox"/>
APPROVED WITH COMMENTS	<input checked="" type="checkbox"/>
REJECTED	<input type="checkbox"/>



Contractors in: **Water Proofing** (Hot, Cold & Acoustic), Buildings, Tunnels, Bridges Off Shores, Swerage System, Base Lining (Environmental & Land Fill Projects) & All Allied Civil Applications

Submission No.: ECC/326/01/7/09
Revision No.: 00

Client	CEYAAR Development PJSC
Project Manager	Skelmore Trident
Engineer	Arab Experts Engg. Consultants
Contractor	Engineering Contracting Company (ECC)
Project	Mayfair Residency, Plot No:BB.A06.047, Business Bay
Sub-contractor / Supplier (if applicable)	TAHIR AMIN INSULATION CONT. Co.
Country of Origin / Manufacture	UAE / Falcon Chemicals
Item Description	Lavatox-2000: High Performance ready to use Cold Applied, High Build Rubber Modified Liquid Waterproofing Membrane.
Location / Use	Wet Areas (Kitchens & Toilets), Balconies & Store-Laundry / Lavatox-2000 Waterproofing
Date of Submission	13/7/2009
Requested date of Approval:	16/7/2009
Specification Clause No.:	Item 10, Chapter 2-B, Section 2, Volume III
Bill of Quantity Item No.	Item 8, Bill No. 7
Particular Specification Clause No.:	Item 06, Section 2, Volume III
Contract Drawing No.	B 601
Shop Drawing No.	NIL
Material Specified	Wet area waterproofing will be liquid membrane reinforced with polythene base and applied rate to include treatment of surface cracks, primer, overlaps...etc
Material Proposed	Lavatox-2000: High Performance ready to use Cold Applied, High Build Rubber Modified Liquid Waterproofing Membrane
Local Agent Name	Falcon Chemicals
Technical Literature	Product Data Sheet and Catalogue Attached
Other attachments if any	Related BOQ, Specifications, Specification Compliance Statement, ISO & Company Certificates, Technical Data Sheet, Test Certificates, Method Statement, Previous Material Approvals, Reference List + Mayfair
Samples	NIL
Reason for Alternative	1. Cost Saving to the Client. 2. Better Productivity and Progress to the Work because its Single Component ready to use directly. 3. Widely used for Wet Area & Balcony with Excellent Performance.

Eng
Arch
MEP
QC
CM
MET
QA/
ENI
QS
P
EST
EG
FILL

CONTRACTOR'S ATTESTATION

For the Contractor	Name: Ahmed Omar	Received by Engineer	Date:
Signature:	<i>[Signature]</i>	Signature:	<i>[Signature]</i>
For Engineer Use	<input type="checkbox"/> API - Approved <input checked="" type="checkbox"/> AWC - Approved with Comments <input type="checkbox"/> RE - Rejected For Record Date: <i>15/07/09</i> Authorized Signature: <i>[Signature]</i>		

RECEIVED
18 JUL 2009 9:05
ENGINEERING CONTRACTING CO. LLC
JOSR 2027A/006

Engineer's Comments	Client's Comments
Lavatox 2000 is approved as water proofing material for Toilet, Kitchen, Laundry, Balcony etc. Subject to following: 1. Applicators prequalification to be submitted for approval. 2. Etc to submit detailed method statement in co-ordination with other disciplines. 3. Delivered material shall be tested by independent Lab to confirm the properties as mentioned in data sheet. 4. Shop drawings to be submitted showing details of corners, drain point, End point etc. for approval. 5. Inspection report to be submitted on each stage including surface preparation. 6. Water proofed areas shall be protected until floor filling is completed. 7. Test samples shall be submitted with 141 weeks time.	Approved

18 JUL 2009
[Signature]



Contractors in: **Water Proofing** (Hot, Cold & Acoustic), Buildings, Tunnels, Bridges Off Shores, Swerage System, Base Lining (Environmental & Land Fill Projects) & All Allied Civil Applications

ARMAN BUILDING CONT. CO. LLC

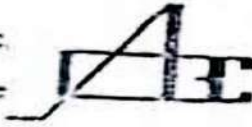

شركة ارمان لمقاولات البناء

SUB CONTRACTOR APPROVAL FORM

Name & Details:	Owner MR. Saled Saad Al Sabri
Consultant: Eng. Adnan Saffarini	Job Title: Water Proofing system

Sub Contractor 1

Tahir Amin Insulation Cont. Co.

Sub Contractor 2

Sub Contractor 3

Attachment List:

1
2



Engineer - Remark:	Approved Subcontractor [Signature]
--------------------	--

Date: _____





Contractors in: **Water Proofing** (Hot, Cold & Acoustic), Buildings, Tunnels, Bridges Off Shores, Swerage System, Base Lining (Environmental & Land Fill Projects) & All Allied Civil Applications

EUROSTAR 5

PROPOSED WAREHOUSE EXTENSION PROJECT
On plot 598-352 AT Dubai Investment Park, DUBAI

SUB-CONTRACTOR APPLICATION FORM

Contractor: M/S. Eurostar Construction LLC Address: DUBAI, U.A.E Tel: 04-8854363 Fax: 04-8854373 Date submitted prepared: 05.10.2008 Description of works to be sub contracted: water proofing works Location: Terrace and wet areas Expected start date: 10/10/08 Dear Sir, Please find attached supporting documents in respect to our proposed sub contractor for the above contract. 1. Name and classification <input type="checkbox"/> Y 2. Details of recent performance. <input type="checkbox"/> Y 3. Type, number and current location of plant/equipment to be deployed on the project. <input type="checkbox"/> Y 4. Full list of names, qualifications and experiences of staff proposed for this project. <input type="checkbox"/> Y 5. Outline method statement of proposed work and performance. <input type="checkbox"/> Y 6. Written confirmation that the proposed sub contractor will act and deliver in full conformity with the contract and the main contractor's construction programme. <input type="checkbox"/> Y 7. Certificates and licenses from all relevant authorities. <input type="checkbox"/> Y Contractor's comments: Please find attached copy of subcontract for regular waterproofing works. Contractor's Authorized Signatory:  Date: Engineer's Comments:  <input type="checkbox"/> Archt. <input type="checkbox"/> Str. Engr. <input type="checkbox"/> M. Engr. <input type="checkbox"/> E. Engr. Status: <input checked="" type="checkbox"/> Approved <input type="checkbox"/> Approved with comments <input type="checkbox"/> Not approved. Revise & submit <input type="checkbox"/> Reject as comments Project manager: Date: Engineer: Date:	Consultant: CHAWLA Architectural & Consulting Eng Address: P.O. Box 261 - Dubai U.A.E Dubai, UAE Tel: 04 3450426 Fax: 04 3450330 Supervisor Ref: EC/598-352/epc/001 Rev. No.: 0 Name of Subcontractor: Tahir Amin Insulation Cont. LLC. Gov. Ref: ECO Ref:
---	---

طاهر امين للتأمين العزل
TAHIR AMIN INSULATION CONT. CO.
Mob: 050 877832 P.O. Box: 44398



Contractors in: **Water Proofing** (Hot, Cold & Acoustic), Buildings, Tunnels, Bridges Off Shores, Swerage System, Base Lining (Environmental & Land Fill Projects) & All Allied Civil Applications

Client	Mr. Tariq Ahmed Abdulla Ahmed		
Consultant	Arch Dome Consulting Engineers		
Contractor	Al Rayan Contracting		
Project	(G+1) Villa, @ Al Barsha 3 rd on plot no. 375-1141		
Sub-contractor (if applicable)	Tahir Amin Insulation Cont. Co		
Item Description	Foam Concrete		
Location / Use	Roof Area		
Date of Submission	25-2-2009	Requested date of Approval:	
Bill of Quantity Item No.		Specification Clause No.:	
Contract Drawing No.			
Shop Drawing No.			
Material Specified			
Material Proposed			
Local Agent Name	Advanced Insulation Mat Industries L.L.C		
Technical Literature	Enclosed		
Other attachments if any			
Samples			
Reason for Alternative			
Notes			
CONTRACTOR'S ATTESTATION			
For the Contractor	Name: Tariq Abdul Latif	Requested by AD	Date: _____ Signature: _____
For Consultant use:	<input type="checkbox"/> APP - Approved <input checked="" type="checkbox"/> AWC - Approved with Comments <input type="checkbox"/> RE - Rejected		
Date:			
Authorized Signature:	[Signature] [Stamp: Tahir Amin Insulation Cont. Co, Mob: 050 9677832, P.O. Box: 44394]		
Comments:	[Signature] [Stamp: RECEIVED 25 FEB 2009]		
Corrections or comments made relative to submittals during this review do not relieve the Contractor from compliance with the contract requirement and specifications. This check is only for review of general conformance with the design concept of the project.			



Contractors in: **Water Proofing** (Hot, Cold & Acoustic), Buildings, Tunnels, Bridges Off Shores, Swerage System, Base Lining (Environmental & Land Fill Projects) & All Allied Civil Applications

Client	Mr. Tariq Ahmed Abdulla Ahmed		
Consultant	Arch Dome Consulting Engineers		
Contractor	Al Rayan Contracting		
Project	(G+1) Villa, @ Al Barsha 3 rd on plot no. 375-1141		
Sub-contractor (if applicable)	Tahir Amin Insulation Cont. Co.		
Item Description	Foam Concrete		
Location / Use	Roof Area		
Date of Submission	25-2-2009	Requested date of Approval:	
Bill of Quantity Item No.		Specification Clause No.:	
Contract Drawing No.			
Shop Drawing No.			
Material Specified			
Material Proposed			
Local Agent Name	Advanced Insulation Mat Industries L.L.C		
Technical Literature	Enclosed		
Other attachments if any			
Samples			
Reason for Alternative			
Notes			
CONTRACTOR'S ATTESTATION			
For the Contractor	Name: Tariq Abdul Latif	Received by AD	Date:
		Signature:	
For Consultant use:	<input type="checkbox"/> APP - Approved <input checked="" type="checkbox"/> AWC - Approved with Comments <input type="checkbox"/> RE - Rejected		
Date:			
Authorized Signature:	[Signature] ✓ Approved ✓ Approved to be used		
Comments:	[Signature] RECEIVED 25 FEB 2009 BY: [Signature]		
Corrections or comments made relative to submittals during this review do not relieve the Contractor from compliance with the contract requirement and specifications. This check is only for review of general conformance with the design concept of the project.			



Contractors in: **Water Proofing** (Hot, Cold & Acoustic), Buildings, Tunnels, Bridges Off Shores, Swerage System, Base Lining (Environmental & Land Fill Projects) & All Allied Civil Applications

SUB-CONTRACTOR APPROVAL FORM			
<input type="checkbox"/> CIVIL		<input type="checkbox"/> ELECTRICAL	
<input checked="" type="checkbox"/> MECHANICAL		<input type="checkbox"/> PLUMBING	
<input type="checkbox"/> FIRE			
SUBMITTAL REF NO. :	006		
EMPLOYER :	DP World - UAE Region, Civil Engineering		
CONSULTANT :	AL JASSIM ENGINEERING CONSULATS		
MAIN CONTRACTOR :	RAD INTERNATIONAL		
PROJECT NO. & TITLE :	(C143JA) Development of Berth 49 at Quay 7, Jebel Ali		
NAME OF Sub-Contractor :	Tahir Amin Insulation Contractor Co.		
SPEC/BOQ/DWG. REF :	Waterproofing for Toilet Block Roof		
FORM SUBMITTED BY MAIN CONTRACTOR :	Hamed Kazemi Name		10-Mar-2014 Date
FORM RECEIVED BY DPW :	Name	Signature	Date
DPW COMMENTS :	<input type="checkbox"/> Approved <input type="checkbox"/> Approved with comments : <input checked="" type="checkbox"/> Submittals is incomplete. The following is required: 1- Present & Past Projects details 2- Type of warrante / guarantee <input type="checkbox"/> Rejected, because :		
DPW REPRESENTATIVE APPROVAL :			DATE :
CLIENT'S APPROVAL :			DATE :
DPW HEAD OFFICE APPROVAL :			DATE :
FORM RECEIVED BY MAIN CONTRACTOR :	Name	Signature	Date

F/Said 2 - 074



Contractors in: **Water Proofing** (Hot, Cold & Acoustic), Buildings, Tunnels, Bridges Off Shores, Swerage System, Base Lining (Environmental & Land Fill Projects) & All Allied Civil Applications

Project Name: Investigation & Drugs Building, Al Ain		Transmittal No.: DEC-RDC-PPC054-2009-SC-011		Revision: 1	
Contract Name: Ms Reem Dubai Contracting LLC		Project No. PPC-054-2009		Date: 30-03-2011	
Project Manager: Ms Secure					
Consultant: Ms DEC					
Contractor: Ms Reem Dubai Contracting LLC				SUBMITTED FOR: 1	
TYPE: SC - Sub Contractor Prequalification				APPROVAL: 1	
SD: Shop Drawing CA: Calculation SM: Sample/Material MS: Method Statement GT: Guarantee				YOUR INFORMATION: 2	
TF: Temporary Facilities MD: Manufacturer's Data CT: Certificates TT: Test Results				COORDINATION: 3	
MR: Mock-up OT: Others SC: Sub-contractor				ACTION:	
				APPROVED: A	
				APPROVED AS NOTED: B ✓	
				REVISE & RESUBMIT: C	
				REJECTED: D	
				INFORMATION: E	
Quantity	Description	Type	Code		
Paper copy				Submit	Action
04	Ms Tahir Amin Insulation Contracting Sub Contractor Prequalification for Waterproofing Works as per enclosed Check list for Roof, Underneath Water Tank, Wet Area and Plant Boxes	SC			
DISTRIBUTION: Original - Contractor Copy 1 - Consultant Copy 2 - Secure Project Management Copy 3 - PPC				30/03/2011 DATE	
Deviation with Tender Specification, if any Specified		Proposed	Savings		
Consultant to enter Action Codes and Remarks. <i>Code B - Contractor should deliver and apply the approved material within vendor list. - All detailed shop drawing and method statement to be submit</i>					
Project Manager Comments: <i>Approved Ms/ Tahir Amin Insulation Contracting as sub contractor for water proofing works. As consultant noted.</i>					
Client Comments: <i>Must follow SPC - Testing</i>					
DISTRIBUTION: Original - Contractor Copy 1 - Consultant Copy 2 - Secure Project Management Copy 3 - Police Projects Committee				13 APR 2011 DATE	
Corrections or comments made relative to submittals during this review do not relieve the contractor from compliance with the requirements of the drawings and specifications. This check is only for review of general conformance with the design concept of the project and general compliance with the information given on the drawings. The contractor is responsible for confirming and correcting all quantities and dimensions, selecting fabrication processes and techniques of construction, coordinating his work with that of other trades, and performing his work in a safe and satisfactory manner.					
ROUTING					
Received by the Consultant Date: 30/3/2011 Signature: [Signature]		Received by the Secure Project Management Date: 17/4/2011 Signature: [Signature]			
Received by the Secure Project Management Date: 31/04/2011 Signature: [Signature]		Received by the Consultant Date: [Date] Signature: [Signature]			
Received by the PPC Date: [Date] Signature: [Signature]		Received by the Contractor Date: 17/4/2011 Signature: [Signature]			

DEC-RDC-PPC054-2009-SC-011

3/11/2011



Contractors in: **Water Proofing** (Hot, Cold & Acoustic), Buildings, Tunnels, Bridges Off Shores, Swerage System, Base Lining (Environmental & Land Fill Projects) & All Allied Civil Applications

LETTER OF TRANSMITTAL
MAYFAIR TOWER ON PLOT A04-040 AT BUSINESS BAY
LOT Ref: ECCLJ22MSIN012 Rev.01
DATE: 16/05/2009

PROJECT: MAYFAIR TOWER BUSINESS BAY
PLOT NO: BB-A04-040
CLIENT: DEYAR DEVELOPMENT PJSC
PROJECT MANAGER: SHELMORE TRIDENT
ENGINEER: ARAB EXPERTS ENGG. CONSULTANTS
CONTRACTOR: ENGINEERING CONTRACTING COMPANY (ECC)
PROPOSED SUB CONTRACTOR / SUPPLIER: Tahir Amin Insulation Cont. Co.

We are sending ATTACHED UNDER SEPARATE COVER VIA

SHOP DRAWING SPECIFICATION AS BUILT Drawing SAMPLES PRE-QUALIFICATION
 R SCHEDULE COPY OF LETTER PAYMENT CERTIFICATE CUBE TEST RESULT OTHER

S/N	DESCRIPTION	DATE	NO. OF COPIES	ATTACHED
1	Pre-qualification Documents for All Standard Insulation Materials for (Roof, Wet Area & Plenary Box Waterproofing Works)	16.05.09	1	YES
2	Company Profile			
3	Company Organization Chart			
4	Trade License			
5	Manufacture Certificates			
6	Previous Projects			
7	Previous Commitments Approvals			
8	Completion Statement			

THESE ARE TRANSMITTAL AS INDICATED ABOVE
 FOR APPROVAL FOR YOUR USE AS REQUESTED FOR REVIEW & COMMENT FOR INFORMATION

FOR ENGINEER:
 Approved
 Approved As Noted
 Rejected

COMMENTS
 Approval Subject to following:
 1) Satisfactory performance at site. (Engineer will monitor the performance of JAC and for each stage of work and final approval will be subject to satisfactory performance)
 2) Warranty for Material and workmanship to be provided as per contract specification
 3) All the procedure to be submitted for approval
 4) Shop drawing and method statement to be submitted for approval
 5) Contractor should check the performance of previous related project by SINDHIA

CONTRACTOR: [Signature] Date: 16.5.09
 ENGINEER: [Signature] Date: [Blank]



Contractors in: **Water Proofing** (Hot, Cold & Acoustic), Buildings, Tunnels, Bridges Off Shores, Swerage System, Base Lining (Environmental & Land Fill Projects) & All Allied Civil Applications

MATERIAL APPROVAL FORM		MAYFAIR RESIDENCY ON PLOT NO. BB-A06-047	
Submission No.: ECC/J325/CIV/083		Revision No.: 00	
Client	DEYAAR Development PJSC	RECEIVED Time at 17 SEP 2009 8:20am	
Project Manager	Skelmore Trident	ENGINEERING CONTRACTING COMPANY (ECC)	
Engineer	Arab Experts Engg. Consultants	Date: 05/09/2009 Time: 8:20am	
Contractor	Engineering Contracting Company (ECC)	* * *	
Project	Mayfair Residency, Plot No:BB.A06.047, Business Bay	A R E X RECEIVED	
Sub-contractor / Supplier (if applicable)	Tahir Amin Insulation Cont. Co.	Date: 05/09/2009 Time: 8:20am	
Country of Origin / Manufacture	1. UAE 2. Saudi Arabia / Energy Projects Development 3. DOW / Arabian Chemical Company. 4. UK / Energy Projects Development 5. UAE	* * *	
Item Description	1. 10mm thick. Light Weight Concrete with dry density 700kg/m ³ to form the slope. 2. 5mm thick. BETAGUM a blastomeric bituminous waterproofing membrane obtained from distilled asphalt modified with thermoplastic resins (APP,IPP). The membrane is reinforced by a non woven polyester 200gr/m ² . both surfaces of the membrane are covered by a plastic film easily. 3. 50mm thick. ROOFMATE*/ROOFMATE SL* Extruded polystyrene rigid foam with skin, coloured blue throughout and 32-35kg/m ³ min. density. 4. 1000 HC BETAFELT GEOTEXTILE Separation Layer. 5. 1.00mm thick. Aluminium Flashing to Upstand. Roof Floor & External Terraces (only 5mm APP Membrane) / Waterproofing Works	Requested date of Approval: 7/9/2009 Specification Clause No.: Chapter 6, Section 2, Volume III Particular Specification Clause Item 06, Section 2, No.: Volume III	
Location / Use	Roof Floor & External Terraces (only 5mm APP Membrane) / Waterproofing Works	* * *	
Date of Submission	3/9/2009	* * *	
Bill of Quantity Item No.	Item A, Bill No. 7 (Roof Waterproofing)	* * *	
Contract Drawing No.	B-604	* * *	
Shop Drawing No.	NIL	* * *	
Material Specified	Refer to attached Compliance Statement.	* * *	
Material Proposed	1. 10mm thick. Light Weight Concrete with dry density 700kg/m ³ to form the slope. 2. 5mm thick. BETAGUM a blastomeric bituminous waterproofing membrane obtained from distilled asphalt modified with thermoplastic resins (APP,IPP). The membrane is reinforced by a non woven polyester 200gr/m ² . both surfaces of the membrane are covered by a plastic film easily. 3. 50mm thick. ROOFMATE*/ROOFMATE SL* Extruded polystyrene rigid foam with skin, coloured blue throughout and 32-35kg/m ³ min. density. 4. 1000 HC BETAFELT GEOTEXTILE Separation Layer. 5. 1.00mm thick. Aluminium Flashing to Upstand.	* * *	
Local Agent Name	Al Sindbad Building Chemicals Co.	* * *	
Technical Literature	Product Data Sheet and Catalogues Attached.	* * *	
Other attachments if any	Related Contract Drawings, BOQ, Specifications, Materials Approvals, Test Reports, List of Previous Executed Projects, Technical Data & Light Weight Concrete Mix Design.	* * *	
Samples	01 No. Sample of BETAGUM Waterproofing Membrane, 01 No. Sample of 50mm thick ROOFMATE* Extruded Polystyrene & 01 No. Sample of 1000 HC BETAFELT Separation Layer and also 1 No. complete Mock-up Sample of all materials & layers.	* * *	
Reason for Alternative	NIL	* * *	
CONTRACTOR'S ATTESTATION			
For the Contractor	Name: Ahmed Omar	Received by Engineer	Date:
	Signature:		Signature:

Material Approval Form-Issued on 15.12.2008_Rev.03 1 of 2



Contractors in: **Water Proofing** (Hot, Cold & Acoustic), Buildings, Tunnels, Bridges Off Shores, Swerage System, Base Lining (Environmental & Land Fill Projects) & All Allied Civil Applications

Client		Mr. Tariq Ahmed Abdulla Ahmed	
Consultant		Arch Doms Consulting Engineers	
Contractor		Al Rajan Contracting	
Project		(G+1) Villa, @ Al Barsha 3 rd , on plot no.-375-1141	
Sub-contractor (if applicable)		Tahir Amin Insulation Cont. Co.	
Item Description		Foam Concrete	
Location / Use		Roof Area	
Date of Submission		25-2-2009	Requested date of Approval:
Bill of Quantity Item No.		Specification Clause No.:	
Contract Drawing No.			
Shop Drawing No.			
Material Specified			
Material Proposed			
Local Agent Name		Advanced Insulation Mat Industries L.L.C	
Technical Literature		Enclosed	
Other attachments if any			
Samples			
Reason for Alternative			
Notes			
CONTRACTOR'S SIGNATURE			
For the Contractor		Received by AD Date: _____ Signature: _____	
For Consultant use:		<input type="checkbox"/> <input checked="" type="checkbox"/> <i>Approved</i> <input checked="" type="checkbox"/> <i>Approved with Comments</i> <input type="checkbox"/> <i>RE - Rejected</i>	
Date:			
Authorized Signature:			
Comments:			
<small>Corrections or comments made relative to submittals during this review do not relieve the Contractor from compliance with the contract requirement and specifications. This check is only for review of general conformance with the design concept of the project.</small>			



Contractors in: **Water Proofing** (Hot, Cold & Acoustic), Buildings, Tunnels, Bridges Off Shores, Swerage System, Base Lining (Environmental & Land Fill Projects) & All Allied Civil Applications

CLIENT		CONSULTANT		CONTRACTOR		
Lamprell Energy Ltd. C/o P.O. BOX 5417 Dubai U.A.E. Tel: 96-4282223, Fax: 96-5284132		Halcrow International Partnership P.O. Box 673, Sharjah U.A.E. E-mail: hpc@halcrow.com.ae 		شركة الجوال للمقاولات M. Jawal Contracting Company		
PROJECT : Construction of 2(Administration and Client)Office Block Facilities - Hamriyah Freezone Sharjah						
Material Submittal				<input type="checkbox"/> New Submittal <input checked="" type="checkbox"/> Re-Submittal		
Submittal No.	JC-M-043-09	Rev.	1	Date :	19/4/2009	
Project No.	24				Contractor :	Al Jawal Contracting Company L.L.C.
Consultant	HALCROW INTERNATIONAL PARTNERSHIP				Sub Contractor :	Tahir Amin Insulation Cont. Co.
Description / Technical Utitrate : Water Proof For Wet Areas With Catalogue						
Attachment: <input type="checkbox"/> Sample <input checked="" type="checkbox"/> Technical Data <input type="checkbox"/> Test Reports <input type="checkbox"/> Method of Statement <input type="checkbox"/> Others						
Area of Application/ Location : Client & Administration Building						
Specs Ref :			Manufacturer Name:			
Origin of Submittal :			Email / Tel no.			
Shop Drawing Submittal Comply with Specification <input type="checkbox"/> Yes <input type="checkbox"/> Alternative						
Details if Alternative						
Contractor AL JAWAL CONTRACTING CO.				Signature		
Attestation						
certified by :						
For Consultant : <input type="checkbox"/> Approved <input checked="" type="checkbox"/> Approved with Comments <input type="checkbox"/> Rejected Date forwarded to Client : Date received from Client :			For Client : <input type="checkbox"/> No Objection <input type="checkbox"/> Objection 			
Comments :						
No objection Manufacturer's recommendation TIME 2m for handling, storage & application must be strictly followed						
Consultant Authorized : Signature/ Date :			Client Authorized : Signature/ Date :			
Signature/ Date : 19/04/09			Signature/ Date :			
Contractors received :						
Material & workmanship shall conform to Arch. Spec. sec. 7.29.						



Contractors in: **Water Proofing** (Hot, Cold & Acoustic), Buildings, Tunnels, Bridges Off Shores, Swerage System, Base Lining (Environmental & Land Fill Projects) & All Allied Civil Applications

CONTRACTOR MATERIAL SUBMITTAL			
INS NO	REV	PROJECT ID	422/291
DATE	17/9/2012		
CLIENT	Abudulla Mohd Al-Shammal		
CONSULTANT	AL SHURROOQ ENGINEERING CONSULTANCY		
CONTRACTOR	Royal Gulf Contracting / TAHIR AMIN INSULATION CONT.		
Description of material			
Submittal Type	<input checked="" type="checkbox"/> Fabricator	<input type="checkbox"/> Manufacturer	<input checked="" type="checkbox"/> Sample
Contract Project Manager Signature	[Signature]		Received By
Date	17/9/2012		Date
CONSULTANT COMMENTS:			
<p>Request Review Comments:</p> <p>* the approved systems are following:-</p> <p>1- Foam Concrete mini & 600 kg/m³ density</p> <p>2- Dermabit primers modified mini 9/m²</p> <p>3- Dermabit 4250 APP</p> <p>4- 1000 Polythene sheet</p> <p>5- 5cm Extruded Polystyrene</p> <p>6- Geo textile sheet</p> <p>7- mortar + mosaic tiles (submit sample for approval)</p> <p>* Water test to be done & checked by Consultant</p> <p>* 10 years guarantee to be submitted.</p>			
Recommendation for Approval:			
Approved	<input checked="" type="checkbox"/>	Submit sample for approval	
Approved with Comments	<input type="checkbox"/>		
Rejected	<input type="checkbox"/>		
Signature Engineer			
Project Manager Review Comments:			
<p>Approved</p> <p>Approved with Comments</p> <p>Rejected</p>			
Signature Project Mgr			

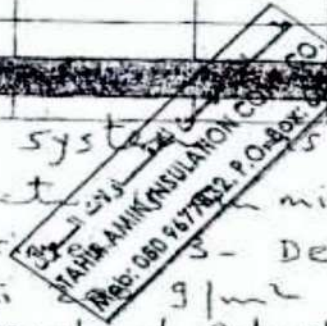

[Signature]
20/9/2012

APPROVED	<input type="checkbox"/>
APPROVED WITH COMMENTS	<input checked="" type="checkbox"/>
REJECTED	<input type="checkbox"/>

A. SHUBQU AL-SH



Contractors in: **Water Proofing** (Hot, Cold & Acoustic), Buildings, Tunnels, Bridges Off Shores, Swerage System, Base Lining (Environmental & Land Fill Projects) & All Allied Civil Applications

Submission No.: ECC/ISS/BCN/7079	
Revision No.: 00	
Client	IDEYAAR Development PJSC
Project Manager	Skelmore Trident
Engineer	Arab Experts Engg. Consultants
Contractor	Engineering Contracting Company (ECC)
Project	Mavfair Residency, Plot No:BB.A06.047, Business Bay
Sub-contractor / Supplier (if applicable)	TAHIR AMIN INSULATION CONT. Co.
Country of Origin / Manufacture	UAE / Falcon Chemicals
Item Description	Lavatex-2000: High Performance ready to use Cold Applied, High Build Rubber Modified Light Waterproofing Membrane.
Location / Use	Wet Areas (Kitchens & Toilets), Balconies & Store-Laundry / Lavatex 2000 Waterproofing
Date of Submission	13/7/2009 <i>Requested date of Approval: 16/7/2009</i>
Bill of Quantity Item No.	Item B, Bill No. 7 <i>Specification Clause No.: Item 10, Chapter 25-B, Section 2, Volume II</i>
Contract Drawing No.	B-601 <i>Particular Specification Clause No.: Volume III</i>
Shop Drawing No.	NIL
Material Specification	Wet area waterproofing will be liquid membrane reinforced with polyethylene base and applied rate to include treatment of surface cracks, pinner, overlaps... etc
Material Proposed	Lavatex-2000: High Performance ready to use Cold Applied, High Build Rubber Modified Light Waterproofing Membrane
Local Agent Name	Falcon Chemicals
Technical Literature	Product Data Sheet and Certificate Attached
Other Attachments (if any)	Related BOQ, Specifications, Specification Compliance Statement, ISO & Company Certificates, Technical Data Sheet, Test Certificates, Method Statement, Previous Material Approvals
Samples	Reference List + Material Approved
Reason for Alternation	1. Cost Saving to the Client 2. Better Productivity and Progress to the Work because its Single Component as applied to use directly. 3. Widely used for Wet Area & Balcony with Excellent Performance.

CONTRACTOR'S ATTESTATION

For the Contractor	Name: Ahmed Ornar Signature: <i>[Signature]</i>	Received by Engineer	Date
For Engineer Use:		Signature: <i>[Signature]</i>	
API - Approved	<input type="checkbox"/>	18 JUL 2009 9:05	
AWC - Approved with Comments	<input checked="" type="checkbox"/>	ENGINEERING CONTRACTING CO. LLC	
RE - Rejected	<input type="checkbox"/>	2017 JES 6 2 16	
For Record			
Date:			
Authorized Signature:	<i>[Signature]</i>		

Engineer's Comments	Client's Comments
<p>Lavatex 2000 is approved as water proofing material for Toilet, Kitchen, Laundry, Balcony etc. Subject to following conditions:</p> <ul style="list-style-type: none"> Applicators prequalification to be submitted for approval. ECC to submit detailed method statement in collaboration with other disciplines. Delivered material shall be tested by independent Lab to confirm the properties as mentioned in datasheet. Shop drawing to be submitted showing details of corners, drain point, End point etc. for approval. Insulation report to be submitted on each stage included by surface preparation. Water proofed areas shall be protected until floor finish is completed. Warranty shall be submitted with the work. 	<p>18 JUL 2009</p>

MADE IN U.A.E. Issued on 15.12.2005

18 JUL 2009

19/07/09



Contractors in: **Water Proofing** (Hot, Cold & Acoustic), Buildings, Tunnels, Bridges Off Shores, Swerage System, Base Lining (Environmental & Land Fill Projects) & All Allied Civil Applications

ARMAN BUILDING CONT. CO. LLC



شركة عرمان لمقاومات البناء

SUB CONTRACTOR APPROVAL FORM

Name & Details	Owner: M.R. Saled Saad Al Sabri
Consultant: Eng. Adnan Saffarini	Job Title: Water Proofing system

Sub Contractor 1

Tahir Amin Insulation Cont. Co

Sub Contractor 2

Sub Contractor 3

Attachment List:



Engineer - Remarks	Approved Subcontractor <i>[Signature]</i>
--------------------	--

Date



Contractors in: **Water Proofing** (Hot, Cold & Acoustic), Buildings, Tunnels, Bridges Off Shores, Swerage System, Base Lining (Environmental & Land Fill Projects) & All Allied Civil Applications



Henkel Polybit Industries Ltd.
P.O. Box 293, Umm Al Ghwain, UAE
Tel. +971 6 7670777, Fax. +971 6 7670197
henkelpolybit@henkelpolybit.com, henkelpolybit.com

هنكل بولي بيت للصناعات المحدودة
ص.ب. 293، أم القيوين، الإمارات العربية المتحدة
هاتف: +97167670777، فاكس: +97167670197

HPIL/AAC/PB/13155/13665/2016
March 9, 2016

To Whom It May Concern

We acknowledge **M/s Tahir Amin Insulation Cont. Co, P.O. Box: 64396, Sharjah**, as a proficient company, specialized in executing waterproofing jobs using our products (Protection Board, Bituplus Range of Membranes, and Bitumen & Non Bitumen Coatings).

Henkel Polybit Industries Ltd recommends M/s **Tahir Amin Insulation Cont. Co** as an approved applicator for executing waterproofing works using our products.

This certificate is valid for 1 year from the date of issue.

Signed on and behalf of M/s Henkel Polybit Industries Ltd.

Authorized Signatory





Contractors in: **Water Proofing** (Hot, Cold & Acoustic), Buildings, Tunnels, Bridges Off Shores, Swerage System, Base Lining (Environmental & Land Fill Projects) & All Allied Civil Applications

HPIL/PR/482/2011
Date: 04 July 2011



هنكل بولي بت للصناعات المحدودة ذم
Henkel Polybit Industries Limited

P.O. - Box 293, Umm Al Quwain, United Arab Emirates
Tel.: +971 6 767 1661 Fax: +971 6 767 1669
Email - polybit@emirates.net.ae
www.henkelpolybit.com

To Whom It May Concern

We acknowledge M/s Tahir Amin Insulation Contg Co, P.O. Box: 64396, Sharjah, as a proficient company, specialized in executing Injection works using Injection range of materials.

Henkel Polybit Industries Ltd recommends M/s Tahir Amin Insulation Contg Co as an approved applicator for executing Injection Works using our products.

This certificate is valid for 6 months from the date of issue.

Signed on and behalf of M/s Henkel Polybit Industries Ltd.

Authorized Signatory



Manufacturers of Quality Waterproofing Products



This is to certify that

M/S TAHIR AMIN INSULATION CONTRACTING CO

Has been registered
as an approved applicator for
project: Akoya2 Oxygen 981 Villas Dubai
with the following Fosroc products

NITOPROOF 30 , NITOCOTE CM210, BRUSHBOND
PROOFEX TOCHSEAL 4S, PROOFEX PRIMER, THIOFLEX 600

For AL GURG FOSROC LLC



Manar Jamhour
General Manager

Valid From : 01st March 2016

Valid Until : 01st Aug 2016

*** Note:** This certificate is issued on request, and we have no contractual obligation whatsoever.

Al Gurg Fosroc LLC

PO Box 657, Dubai, United Arab Emirates, Tel: 04 2039699, Fax: 04 2859649
email: agf@fosroc.com, www.fosroc.com



Contractors in: **Water Proofing** (Hot, Cold & Acoustic), Buildings, Tunnels, Bridges Off Shores, Swerage System, Base Lining (Environmental & Land Fill Projects) & All Allied Civil Applications

MASTER®
BUILDERS
SOLUTIONS

APPROVED APPLICATOR CERTIFICATE

This certifies that

TAHIR AMIN INSULATION CONTRACTING CO.

have been registered as an Approved Applicator
and demonstrated competence in applying
the following BASF Construction Chemicals products

MasterSeal 588 (Formerly known as Thoroseal FX100)

For and on behalf of

BASF Construction Chemicals UAE LLC

Julian Pritchard

Head of Market Management Middle East/
General Manager



Valid from: 01st January, 2016

Valid until: 31st December, 2016

(subject to periodic site inspections)

Ref: APC0623 - R/170318 - Tahir Amin Insulation Contracting Co. (MSel 588).docx

BASF
We create chemistry



PROTECT MIDDLE EAST L.L.C.



بروتكت الشرق الأوسط ذ.م.م.

Ref. No: PME/16344A/2011

DATE : 31-March-2011

SUBJECT : APPROVED APPLICATOR
PROJECT : INVESTIGATION & DRUGS BUILDING IN AL AIN

TO WHOM MAY IT MAY CONCERN:

We, Protect Middle East, confirm that M/s Tahir Amin Insulation Cont. Co. is an approved applicator/installer of Flexigum membrane from M/s Atab, Belgium for the waterproofing works for **Investigation & Drugs Building in Al Ain project only**

Best Regards,
FOR PROTECT MIDDLE EAST L.L.C.

JOSEPH GEDEON
Managing Director





Contractors in: **Water Proofing** (Hot, Cold & Acoustic), Buildings, Tunnels, Bridges Off Shores, Swerage System, Base Lining (Environmental & Land Fill Projects) & All Allied Civil Applications

ADVANCED
CONCRETE TECHNOLOGY
(Construction Chemicals)

ACT

تكنولوجيا
الخرسانة المتقدمة
(وكيماويات البناء)

ACT/AJ/100/09
November 17, 2009

TO WHOM IT MAY CONCERN

We acknowledge *M/s Tahir Amin Insulation Cont. B. O. Box 84396 Sharjah UAE* as a proficient company, specialized in waterproofing system using our products (Actseal NT)

ACT recommends *M/S Tahir Amin Insulation Contracting* as an approved applicator for executing quality waterproofing jobs using our products



For ADVANCED CONCRETE TECHNOLOGY

Auth. Signatory



المكتب الرئيسي - شارجة - ٢١١١٤٤١٨٨ - فاكس ٠٦-٧٤٥٣١٧٠ - ص.ب. ٧٢٣٠ - أبو ظبي - الإمارات العربية المتحدة
مكتب جسر القديس - فاكس ٠٦-٧٤٥٣١٧٠ - ص.ب. ٧٢٣٠ - عجمان - الإمارات العربية المتحدة
Main Office : Tel. : (02)6655288 - Fax : (02)6668357 - P.O. Box - 8090 - Abu Dhabi - U.A.E.
Ajman Office : Tel. / Fax:(06)7482828 - P.O.Box : 7230 - Ajman - United Arab Emirates



IMRAN ENTERPRISES FZC

September 28, 2014

Subject: Work Completion Certificate

Project: Supply and Application of Liquid Water Proofing Material to Imran Enterprises FZC, Plot P4-10 SAIF Zone, Sharjah.

To whom it may concern. We, **IMRAN ENTERPRISES FZC** that **M/s Tahir Amin Insulation Cont. Co.** has completed the work within due date. We appreciate them for quality of work, work progress and their expertise.

Imran Enterprises Fzc

Best Regards

For **IMRAN ENTERPRISES FZC**

Shanour Pirbay
General Manager



جيتي للمقاولات العزل
Construction Co (L.L.C)

Date: 29 Oct 2014

Work Completion Certificate

Project : Tariq Gargash Farmhouse
Location : Lehbab, UAE

To whom may it Concern, M/s Tahir Amin Insulation Cont. Co. has completed the work within due date. We appreciate them for quality of work, work progress and their expertise.

Best Regards

Giti Construction L.L.C
Dubai, UAE

Tahir Amin
29/10/2014



Tel : 04 - 3978799 (4 lines)
Fax: 04 - 3978798
P.O. Box : 118935, Dubai-U.A.E.
E-mail : giticonstruction@emirates.net.ae
Website : www.giti-construction.com



توكل لمقاومات البناء ش.ذ.م.م.
Tawakkal Building Contracting L.L.C.

Ref: CV003/073/05/14

Date: 4-Nov-14

Subject: Work Completion Certificate

Project:

To whom it may Concern. We Tawakkal Building Contracting L.L.C. Certify that M/s Tahir Amin Insulation Cont. Co. has completed the work within due date. We appreciate them for quality of work, work progress and their expertise.

Best Regards

For Tawakkal Building Cont. LLC



Contractors in: **Water Proofing** (Hot, Cold & Acoustic), Buildings, Tunnels, Bridges Off Shores, Swerage System, Base Lining (Environmental & Land Fill Projects) & All Allied Civil Applications

ARIF & BINTOAK		Project No. 1511								Material Approval Request	
DIST.	FOR INSULATION	FOR ACTION									
PD	Benoy		Cracknell								
RE											
SE											
EE	Project Title : JBR Enhancement (The Walk & Podium)		The Employer : Estithmar Reality FZ-LLC		Lead Consultant The Engineer Contractor : Benoy Arif & Bint oak Shapoorji Pallonji Mideast LLC						
ME											
QS	Submittal Ref No		Revision		Date of Submittal						
Insp (MEP)	SPML-BNY-1511-JBR-MAT-376		00		19-Sep-2015						
Insp (Civil)											
DC	Material Discipline:										
COMMENTS:	Architectural	<input checked="" type="checkbox"/> Civil	Mechanical	Electrical	Plumbing	Landscaping	Other				

Material Title : Water Borne Intumescent Acrylic Sealant	Specification Ref No:	Drawing Ref No:	ISO Ref No: RECEIVED 20 SEP 2015
Supplier/Subcontractor name: M/s. Tahir Amin Insulation Cont.Co		Address : Dubai U.A.E	Subcontractors Ref No:

No	Description - Specified	Description - Proposed
1		FOR INTERFACE BUILDING AND NEW RETAIL

Attachments:	1- Product data/ Catalog	Yes	2- Specification	Yes	3- Samples	Yes	4- Others	
---------------------	--------------------------	-----	------------------	-----	------------	-----	-----------	--

The Contractor has reviewed the submission prior to submission to The Engineer		Received by The Engineer	
Reviewed by Contractor	Approved for Submittal by Project Director	Signature:	
Signature:	Signature:	Signature:	
Date:	Date:	Date:	

For Use By Lead Consultant/ the Engineer:
Comments:
 No objection subject to:
 - fully compliance with contract demands
 - Applying as per manufacturer recommendations

Approval Status	<input type="checkbox"/> A Approved	<input checked="" type="checkbox"/> B Approved as Noted	<input type="checkbox"/> C Revise & Resubmit	<input type="checkbox"/> D Rejected	<input type="checkbox"/> E Other
The Engineer's Signature	Lead Consultant Signature				
For and on behalf of Arif & Bint oak	For and on behalf of Cracknell (As applicable)		For and on behalf of Benoy		
Date: 20.09.15	Date:		Date:		

Note: Corrections or comments made relative to submittals during this review do not relieve the contractor from compliance with the requirements of the drawings and specifications. This check is only for review of general conformance with the design concept of the project and general compliance with the information given in the contract documents. The contractor is responsible for confirming and correlating all quantities and dimensions selecting fabrication processes and techniques of construction; coordinating his work with that of other trades, and performing his work in a safe and satisfactory manner.

CC: Employer: 1 Copy (With All Attachments) (Cover Page only)

Received By (contractor) - One copy with Attachment	Signature:	Date:
--	-------------------	--------------



Warranty Specimen

Ref :

Date

M/s.

WARRANTY

TAHIR AMIN INSULATION CONT. LLC. Warranty their Waterproofing system materials and workmanship installed for Project (Aream²) **MATERIAL USED -** **FINISH MEMBRANE** in accordance with the Specifications, for a period of 10 (ten) years from To..... subject to the following terms & conditions:

1. This Warranty shall be limited to the free supply and installation of specified materials to the satisfaction of client, consultants and main contractor in the defective area where failure has been caused by faulty materials or workmanship and shall not cover other damages or defects howsoever caused to the property due to water leakage.
2. It shall be the owner's responsibility to notify **TAHIR AMIN INSULATION CONT. LLC** for any defects in the Waterproofing system and this Warranty shall be void if repairs or other works relating to Waterproofing system are carried out by third parties.
3. This Warranty shall only apply to the areas where waterproofing system has been installed by **TAHIR AMIN INSULATION CONT. LLC** and shall be void if repairs or other works relating to Waterproofing system are carried out by third parties.
4. The supply of replacement materials under this Warranty shall in no event exceed the quantity originally executed and shall only be applied to such areas.
5. This Warranty is limited to the supplying and replacement of faulty materials and workmanship and shall not cover any consequential loss or damage no matter how such loss or damage is caused.
6. Our Waterproofing warranty will become null and void if the Waterproofing system fails due to structural alterations carried out at site, structural movement / settlement of the building, cracks in the slab / wall due to structural defects, and failure of dewatering pumps during installation of the Waterproofing system, etc.



Contractors in: **Water Proofing** (Hot, Cold & Acoustic), Buildings, Tunnels, Bridges Off Shores, Swerage System, Base Lining (Environmental & Land Fill Projects) & All Allied Civil Applications

7. This Warranty stands valid only after receipt of full and final payment by us.
8. This Warranty shall be interpreted according to the laws of the United Arab Emirates.
9. The Waterproofing works have to be protected against damage by taking precautions listed in the Annexure enclosed.

THIS WARRANTY IS SIGNED ON..... SEALED AND DATED BY THEIR ACCREDITED REPRESENTATIVE IN THE UNITED ARAB EMIRATES SUBJECT TO THE TERMS AND CONDITIONS STATED ABOVE.

Eng. Tahir Amin
General Manager
+971 50 9677832

For Tahir Amin Insulation Contracting LLC

 **+971 50 9677832**
 **info@taic.ae, insulation008@gmail.com**
 **www.taic.ae**  **@taicllc2008**
   **completewaterproofingsolution**

Encl: Annexure

This Warranty is signed without any correction in its contents. If any correction is found later on, the entire warranty will be null and void.



Annexure

LIST OF PRECAUTIONS TO BE TAKEN BY MAIN CONTRACTOR / CLIENT FOR NOT DAMAGING THE WATERPROOFING WORKS

A) SUBSTRUCTURE

- 1) The protection boards in the vertical areas should not be damaged by needle vibrators, covers blocks, scaffolding, reinforcement, nails, etc. and they should not be removed in any circumstances.
- 2) For all Verticals areas, Protection board should be protected further by 3 mm plywood placed on top of it temporarily while tying reinforcement. The plywood can be removed after reinforcement work is done and before concreting. This is mandatory.
- 3) The screed laid above the horizontal areas should not have any sharp object that will puncture the membrane. Before pouring screed membrane must be covered with 1000 gauge polyethylene sheet. Workers laying the screed should not wear Safety shoes as they can puncture the membrane. They should wear only Shoes with soft sole. Also they should avoid moving wheel barrows above membrane.
- 4) Placing of reinforcement, sand, stacking of cement bags, tool & tool box, cover blocks, or hallow blocks above the waterproofing membrane should be totally avoided.
- 5) Dewatering should be continuous, uninterrupted until the Raft Slab or Ground Slab and retaining walls are casted. Standby pumps should be readily available in case of the pump stops or else the ground water may enter the membrane from beneath and destroy the homogeneous membrane system. This may result in heavy leakages later on.
- 6) The Protection screed above membrane in Ground level should be laid in such a way that at least a minimum of 150 mm of previous membrane is available for the continuous lapping of new membrane.



ROOF

- 1) After waterproofing membranes/ liquid application coats are laid and tested with water, movement of personnel on the roof should be curtailed, as even shoes with sharp soles can puncture the membrane.
- 2) After granule membrane has been laid, no further civil works relating to erection of A/C units, drain water outlets pipes, Dish Antenna should be carried out as all the activities can puncture the membrane. If in case any such activity is to be carried out it should be done under the supervision of personnel from **Tahir Amin Insulation Cont. LLC**
- 3) If tiles are to be laid above the membrane, the pallets or individual tiles should not be kept directly on the membrane and should be stacked and laid in such a way that the tiles do not damage the membrane. Also a separation layer such as a high gauge Polythene Sheet should be in between the membranes and the top finishing layer.
- 4) Movement of personnel for any maintenance work on the roof should be restricted to only areas where membranes have been protected with tiles, etc.

B) WET AREAS

- 1) After membrane is laid and tested for water, the area should be cordoned off for any other activity. Laying of tiles etc. should be done with utmost the care not to damage the waterproofing membrane and a separation layer such as high gauge Polythene sheet should be in between the membrane and the top finishing layer.
- 2) No cutting or piercing of the membrane is allowed for location, relocation of soil pipes, water supply pipes, erection of sanitary ware, etc... If such activity is to be carried out it should be done only under the supervision of **Tahir Amin Insulation Cont. LLC**

IF THE ABOVE PRECAUTIONS ARE NOT TAKEN BY THE MAIN CONTRACTOR /CLIENT, AND THE WATERPROOFING MEMBRANE IS FOUND TO BE DAMAGED LATER ON BEACUSE OF SUCH ACTIVITIES, THEN NO GUARANTEE FOR OUR WORKS WILL BE APPLICABLE AND ANY REPAIR ARISING OUT OF SUCH ACTIVITIES WILL HAVE TO BE PAID BY THE MAIN CONTRACTOR / CLIENT

Conventional Roofing System

Contents

- | | |
|--------------|----------------|
| 1. Scope | 4. Material |
| 2. Purpose | 5. Procedure |
| 3. Reference | 6. Attachments |

1. Scope

The scope of this method statement covers the roofing system.

2. Purpose

The purpose of this method statement is to describe the material, equipment used, work procedures and the associated QA/QC and safety plan for roofing system.

3. References

- Project Specification
- Manufactures recommendations as per the relevant data sheet
- Applicable standards and codes

4. Materials

- Foaming agent for LWC (light weight concrete)
- Waterproofing Primer
- Waterproofing Membrane,
- Thermal Insulation Boards
- Separation Layer

5. Procedure

Refer to attached method statement for the system application detail.

1. Roof Slab
2. Foam Concrete
3. Primer Coat
4. Waterproofing Membrane
5. Mineral Membrane
6. polystyrene / Thermal Board
7. Separation Layer / Geo Textile
8. Tiles
9. Stones
10. Aluminum Flashing
11. Mastic Sealant

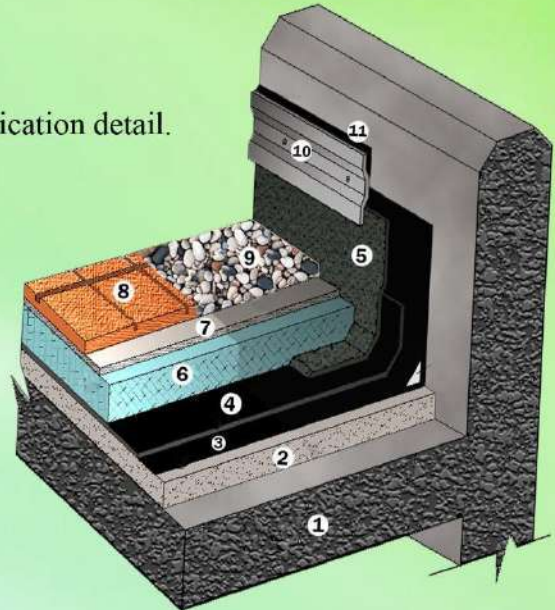



Light Weight Foam Concrete

Introduction

The light weight screed is a foam cellular screeding material when applied over a structure concrete deck, it form a strong continuous, fireproof layer with considerable thermal insulation properties and provide effective slope for proper drainage.

The mixing and casting of the light weight screed is done with an automated machine mainly composed of mixer, aerator, pump, water reservoir, electric panel board and related accessories all set on special trailer.

The finished surface of the light weight screed is smooth, strong and easily repairable in case of any crack development. However, due to its relatively high shrinkage factor, in comparison to normal concrete or screed, the development of hair and minor cracks is an unavoidable phenomenon

Mix Design

For an average dry density of (700 kg / cbm), the following mix design is to be implemented for cubic meter.

✚ Cement consumption	320 Kg
✚ Sand consumption	320 Kg
✚ Water consumption	150 Kg
✚ Foaming agent consumption	1.2 Ltr.

Method of Application

The foam concrete is casted in multiple layers, as the multiple density casting is an accepted method of placing, provided each layer thickness is not less than that of minimum accepted of 50mm and not more than the maximum accepted of 100 mm.

Set the foam machine. As the foaming agent, water and cement elements ratio depends on the specific density design for the project.

Deck surface should be swept clean, i.e. shall be clear of standing water, dirt, construction debris and other foreign materials.

Prior to initiating the casting, the deck slope and level are set using metal guidelines bars and chalk line marks on up stands, create placement bays.

Immediately before casting the light weight screed, the concrete deck surface shall be moistioned. the first casted foam layer shall be left for 12 hours to set, during this setting period no traffic is allowed.



The same will be repeated for the subsequent layers until reaching the finished upper layer, which finishing is done by using straight edge aluminum finishing bar. An average of 5% tolerance is anticipated in the finishing of light weight screed surface level. after 12 hours from casting, the finished level surface of light weight screed shall be water cured, one or more time a day (depending on prevailing weather condition), during which it will be covered by jute mate or polyethylene sheet. Afterwards, it will be left for 2 to 3 days for complete dry up.

Finally, damage to the light screed surface shall be repaired with sand cement mortar mix with suitable bonding agent (SBR or Acrylic based) added to the mix.

The various components of light weight cellular screed are introduced into the cement mixer as follows:

Water, Cement and Foaming Agent

While the cement mixer is in motion, the water and cement are introduced, subsequently the right quantity of foam is automatically injected, which is directly related to quality of cement. The mixing process must then continue until all the foam is completely mixed with liquid mortar, whereby white foaming will appear on top face of mixer. It is advisable to complete the three operations, mixing, transportation and casting as quickly as practical in order to ensure successful results.

Foaming Agent

Foaming agent is a chemical agent obtained by a means of special transportation process of natural macromolecules proteic origin hydrolyzed in a water solution. Foaming agent has been specially designed to produce performed form necessary to obtain the light weight cellular foam screed.

The foaming agent is dark brown liquid when used properly it will produce white foam.

The addition of the agent to cement mix will change the color of mix to a lighter shade of gray.

Physical properties: - Please refer to enclosed data sheet.

Resulted Light Weight Screed

Average dry density	700kg/ cub	ASTM C-796
Average Compressive Strength	20.6kg/ sq. m	ASTM C-796
Thermal Conductivity Coefficient (a)	0.160 w/ mk	ASTM C-518
Flammability	none	ASTM E-84

Notes on Compressive Strength

In general, the main demand on the quantity of light weight screed is a certain compressive strength and specific density. However, unlike the regular screed, the compressive strength of air dried light weight screed is strongly influenced by its age and even more by its moisture contents.

One year after production, the compressive strength of light weight screed is increased by 40%. After two years it increases by 60%.

Therefore, the increase in strength slows down and remains practically constant.



MAS FOAMCEM

General Description:

MAS FOAMCEM is an efficient low dosage foaming admixture, which is used to produce lightweight foam concrete for a variety of insulation and construction applications. It contains tensoactive material and natural protein from animal.

Major Uses:

MAS FOAMCEM helps to produce a stable aerated mortar, by entrapping air into prepared cement slurry in the shape of discontinued air bubbles, to form a cellular structure throughout the mass. The cellular structure significantly reduces the thermal conductivity and density of concrete, resulting in a lower dead load imposed on the structure. It provides excellent resistance to freeze and thaw.

Uses:

MAS FOAMCEM can be used in the production of low density foamed mortar and concrete.

- As flat roof insulation screeds.
- Insulated floor screeds.
- As a backfill concrete.
- Fabrication of light weight beams, blocks and panels.
- Fire barrier/
- Sound insulation of walls and ceilings.
- As encasement concrete.

Advantages:

- High efficiency even at low dosage.
- Excellent stability in alkaline conditions.
- A 1% aqueous solution creates a stiff white foam with 40 to 50 times increase in volume.
- It can be used with all types of light weight aggregates to produce very low density concrete mixes.

Typing Properties:

Appearance:

Translucent, pale brown liquid

Specific gravity:

About 1.02 at 25°C

Solubility:

Infinitely soluble in water.

Chloride Content:

Nil to BS 5075

Water absorption:

Absorption of foamed cement containing 60% voids after 3 months immersion in water, shows only 20% increase in volume.

Toxicity:

Non toxic

Compatibility with cement:

Compatible with Portland cement.

Shelf life:

At least 24 months if stored in tightly closed containers at normal ambient temperature.

TAHIR AMIN INSULATION CONT. CO.
P.O. Box 195
050 9677832, Mob: 050 9677832

Directions for Use

The optimum dosage and performance of MAS FOAMCEM is best assessed after preliminary tests on site using the actual mix design and the job under consideration.

Pre - foaming method:

MAS FOAMCEM is a concentrated material and should be diluted with water to prepare a 1% solution. The diluted solution is used to produce pre - foam by passing through a foam generating machine which produces a uniform and stable foam having a volume of 40 to 50 times that of the original solution. As an alternative, the water and foaming agent can be fed separately into the foam generator, which mixes it uniformly to produce foam. Add the pre - foam into the cement or sand cement slurry within a suitable concrete mixer.

Dosage:

The dosage of MAS FOAMCEM required will vary due to a number of factors including the final mortar density, mixing method and starting materials.



Contractors in: **Water Proofing** (Hot, Cold & Acoustic), Buildings, Tunnels, Bridges Off Shores, Swerage System, Base Lining (Environmental & Land Fill Projects) & All Allied Civil Applications

Overdosing:

MAS FOAMCEM is an air-entraining agent. The compressive strength of any mix will get reduced with increase in the content of MAS FOAMCEM as the level of entrained air will be increased.

Overdosing of MAS FOAMCEM will normally produce an increase in air content, workability together with loss in compressive strength.

Mix ratios:

Typical mix batches to produce approximately 1.0m³ of foamed concrete.

Dry density Kg/m ³	Sand Kg.	Cement Kg.	Water Kg.	Foam Kg.
1200	780	350	140	0.3
1000	500	400	160	0.32
820	360	360	140	0.3
800	---	600	140	0.3
600	---	450	180	0.31
400	---	310	124	0.63

The above batches involved the use of a prefoaming solution of 1 part of MAS FOAMCEM with 100 parts of water. The most appropriate w/c ratio recommended is 0.4 to 0.45.

Storage:

Preferably store in sealed conventional container, protected from extreme weather conditions.

Packaging:

MAS FOAMCEM is supplied in 200 lit. PVC Coated Drums

The above information is given to the best of our knowledge based on laboratory test and practical experience. However, as the paint is often used under condition beyond our control, we cannot guarantee anything but the quality of the paint itself. We reserve the right to change the given data without prior notice.

FACTORY	:	P.O. BOX NO: 23085, SAJJAH INDUSTRIAL AREA, SHARJAH, U.A.E	TEL : 06 - 5311777, FAX 06 - 5311330:
SHOWROOM	:	P.O. BOX NO: 23085, INDUSTRIAL AREA, SHARJAH, U.A.E	TEL : 06 - 5328533, FAX 06 - 5328610
Website	:	http://www.maspaints.com/	Email : masuae@emirates.net.ae



D-111/2004

Safety Precautions:

MAS FOAMCEM is non-toxic and non-flammable. Splashes to eyes and skin should be washed off at once with water. It is advisable to use goggles and gloves while handling MAS FOAMCEM.

coated concrete made by MAS FOAMCEM is of lightweight and free flowing. It can be placed easily by pumping and does not require compaction or levelling. It has superior strength, excellent resistance to water and frost and provides a high level of sound and thermal insulation. The thermal conductivity of foamed concrete is only 5 to 20% that of dense concrete.

طاهر امين للمقاومات العزل
TAHIR AMIN INSULATION CONT. CO.
Mob: 050 9677832, P.O. Box: 64396



Waterproofing Membrane and Thermal Insulation **Method Statement**

A)

Loading/Unloading

Waterproofing membranes are made to resist the mechanical stress they undergo during application. However, handling operations should be carried out with care to prevent squashing or contact with sharp or pointed surfaces which may cause the membrane to damage.

Storage

The material should be stored covered, vertically and on smooth flat surface.

Handling on Site

Only keep on site the number of rolls necessary for the days use. Place the rolls upright on a flat, smooth surface. Use a suitable lifting to position the rolls on to the surface.

Application

Base

LWC substrate should be well covered, sound, clean and dry before application;
All direction changing should be prepared by angle fillet or champher.

Priming

Bituminous primer is spread on the area where membrane will be anchored, and to be leave to dry between 6 and 24 hours

Horizontal Application

First layer

The first layer of modified bituminous waterproofing membrane is to lay directly on dry primed surface by fully bonding application. Unroll the sheet and align it by overlapping the edge on the nearest sheet, then partially roll it up again from both the ends and start flame bonding process. The underside of the sheet is the surface to be treated. It is lined with the thin film (Flamina). When heated it melts to indicate when the material is ready for bonding.

Use the right level, as further heating can cause the polyester to be damage (shrinkage, waving, curling and even burn)



While insufficient heating will not bond the material adequately between layers or an overlap.

Second Layer

The second layer sheet should be placed centrally on top of first layer overlaps and must be completely flame-bonded. However, the first layer and second layer shall be 500mm staggered

Overlapping

Side to side overlaps should not be less than 100mm wide. The sheet should be carefully bonded until a bead of compound about 1cm wide is squeezed out of the joint along the overlap line.

Head to tail overlaps should not be less than 150mm wide with the same carelessness of side to side overlap.

Vertical application

Both the first layer and second layer are fully bonded applied, the sheet and the laying surface are both heated and the material is held in place until it cools enough for adhesion to take place.

General Requirements

- ✚ All sharp edges shall be smoothed or chamfered so as not to puncture the membrane.
- ✚ Detailing to up stands pipe penetrations, external and internal corners shall be completed carefully as per manufacturer's instructions, design drawing and project specifications.

B)

General Method Statement for Membrane

Application

Procedure may vary slightly depending upon the site conditions. However below given are the general guidelines for the application of waterproofing system.

Surface preparation

The surface should be free of dust, dirt; curing compound, oil etc. clean the surface thoroughly to remove the all loosely adhering particles and cement laitance. All surface imperfections and protrusions are to be



removed and repaired. Structurally unsound friable concrete must be removed and repaired with a suitable mortar.

Priming

Apply primer @ 4-6 m²/ ltr. As per AATM41 to a clean smooth and dry surface by brush, roller or spray. Refer primer data sheet for more detail. Allow the primer to dry prior to the application of membrane.

Alignment

Unroll and align the membrane roll and reroll correctly before torching side and overlap should be minimum of 100 mm.

Torching

Use gas torch to heat the substrate and the underside of membrane. When the embossing on the membrane start to disappear during torching the membrane is ready to stick. Roll forward & press firmly with the roller against the substrate to bond well.

Caution: Don't over torch as this will expose the reinforcement in the membrane and cause damage to it.

Sealing

Heat both the overlap and use a round tipped trowel to seal the overlap. Excess compound should be smoothed and pressed into the seam using a heated trowel

Up Stand

All angles and abutments should be sealed with extra care to ensure full bonding. Seal the edges well into the grooves and protect with some suitable mastic sealant.

Product Advantage

- ✚ Highly resistance to positive water & vapor pressure
- ✚ Good dimensional stability under tension
- ✚ Excellent flexibility
- ✚ High puncture & fatigue resistance
- ✚ High tensile & tear strength
- ✚ Resist water born chemicals
- ✚ Accommodate structural movement.
- ✚ Excellent cold temperature flexibility



Storage

Membrane roll are to be stored vertically in clean covered area preferably on pallets. The roll should be at no point of time being stacked on top of each other.

Safety precaution

Any naked flame should be kept away from the gas cylinder. When ignited the torched should be watched all the times. The torch should not be rested on finished roofing. Excellent care should be taken when working near combustible materials. Or items which might be scorched by the gas flame.

Disposal

Membrane is non-hazardous, non-flammable and therefore can be disposal into any regular disposal area. However, it should be disposed only after wrapping with paper, plastic

Or cloth as the modified bitumen has a tendency to soften under heat and pressure which would make future handling very tough.

Health & Safety

Membrane has a tacky bitumen compound which, while applied can stick to human skin. Such stain can be removed by using cloth dipped in a light solvent. In case the affected area is sensitive area it is advised medical attention should be given.

Thermal Insulation

The extruded polystyrene boards should be applied loose, with tight staggered joints over the waterproofing membrane.

Separation Layer

The water permeable filter synthetic fabric, non-woven polypropylene base should be installed on the top of thermal insulation boards

Liquid Applied Waterproofing

METHOD OF STATEMENT

Proposed wet area water proofing system shall include following materials and work to be supplied and installed by **TAHIR AMIN INSULATION CONT. LLC**

- 1) The surface should be free of dust, dirt, curing compound, & oil etc. the surface should clean thoroughly to remove all loosely adhering particles cement laitance etc. All surface imperfections & protrusions to be remove & repaired
- 2) Supply and spray apply **BAYMER/DESMODUR (BAYER)** sprayed polyurethane at an average thickness of 30 - 40mm over the entire roof area including the up stand to a height of maximum 200mm.
- 3) Supply and brush/roller apply **POLYTEX (POLYBIT)** UV resistant coating over the entire PU covered roof area including up stands and allow to dry for 48 hours





GRP Lining

Scope of Work:

Scope involves 4mm thick GRP Lining on Underground Water Tank as per procedure below. Same will be executed and monitored by Site In charge. Material Storage space has to be given by Main Contractor. Surface Preparation should be done by main contractor.

Surface cleaning will be done by using broom and brush to remove dust. Chamfers & Fillet required for bottom and wall joining area will be done by main contractor.

Minimum 2 opening are required for ventilation and 2 no's of Exhaust fan will be placed away from the manhole and extend the hose nearer to the working area. Same procedure shall be followed for working in different area.

Installation of GRP Lining

After surface preparation and removal of dust, one coat of flow coating is applied using woolen roller brush.

Ensure that the resin filled in all voids on the concrete surface so as to avoid the formation of air bubbles. Otherwise the same will lead to cracks in lamination later. In Tackiness stage of resin, first layer of CSM is applied with resin.

Metallic/steel roller is used for proper impregnation and to remove any air entrapment.

Ensure the CSM (Chopped Strand Mat) is completely wet.

Continue the laying process on the remaining area. Overlapping up to 25mm applied.

After one layer of lying, apply resin and put second layer of CSM over the first layer.

Again apply metallic roller.

Ensure again the CSM is properly wet.

Successive layer of CSM is placed one by one with resin over the existing layer (repeat above steps) for achieving required thickness.

Gel coat will be applied for achieving better finish. For better finishing and to avoid pinholes once again apply gel coat.

Allow sufficient time for curing (minimum 24 hrs.). Ensure that, sufficient time is give for curing the successive glass fiber impregnation to avoid peak exothermic heat.

During lining many materials are used, ensure that the site is cleaned properly and wastage are disposed of before inspection/handing over.

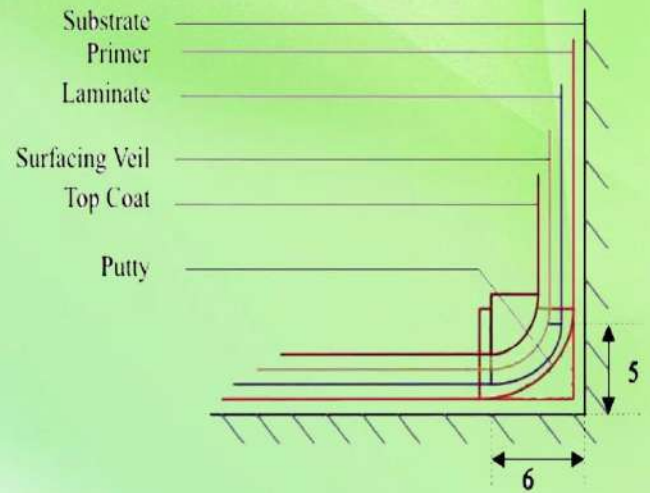
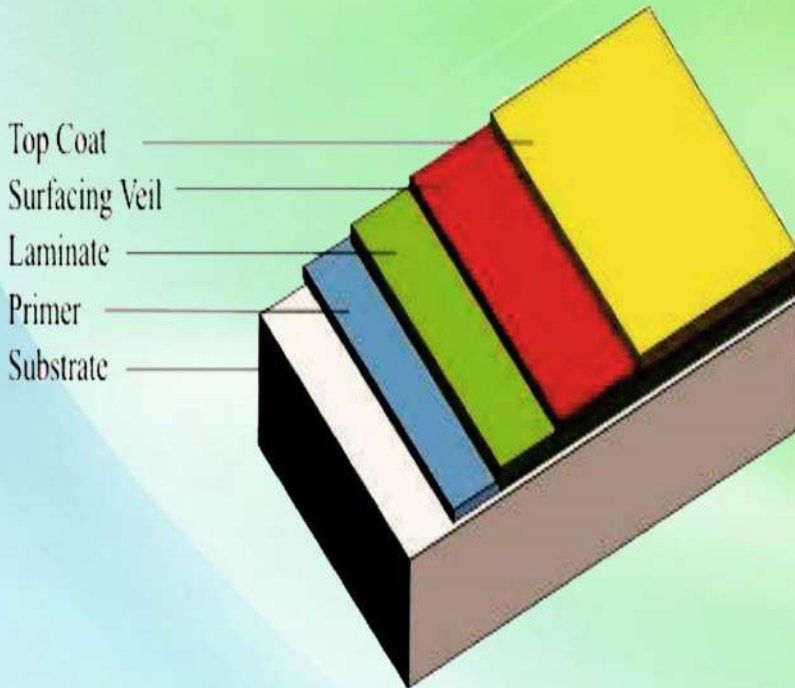

*** Putty is needed in welded and sharp angle side.



OCPOL 711-FR

Ocpol 711 is an fire retardant, thixotropic, orthophthalic unsaturated polyester resin. The resin is pre-accelerated. It imparts outstanding fire retardant properties and is suitable for such applications

Recommendation for Laminating:

Parts by weight:

Ocpol 711 -FR	100
Catalyst K 10	2 ml

Applications:

- To start the curing reaction, take 100 parts of resin.
- Catalyst K10 should be added to the resin system shortly before application to initiate the polymerization reaction.
- It is important to add the catalyst in carefully measured amounts to control the polymerization. Too much catalyst will cause too rapid a gelation time, whereas too little catalyst will result in under cure
- Care must be taken to avoid explosive violence. Do not mix catalyst and cobalt octate or any accelerator together.

Properties of Liquid Resins:

Appearance	Cloudy
Color	Pinkish
Viscosity at 25°C (Brook field , sp. 3@60 rpm)	400 - 500 cps.
Gel Time at 25°C	12 - 18 min
Acid value mg KOH/g	< 26
Solid content %	58±1
Specific Gravity at 25°C	1.11 - 1.13
Peak Temperature	>170



Properties of fully cured resins (unfilled casting):

Barcol hardness (Model GYZJ 934 - 1)	43 - 47
Water absorption 24 h at 23°C	16 - 19 mg
Elongation at break at 20°C	1.9 - 2.2 %

Packing:

Ocpol 711-FR is supplied in 220 Kg new steel drums with close top.

Safety:

Due attention should be given to the precautions for handling chemicals provided in our Material Safety Data Sheet.

Remarks:

The information submitted in this publication is given in good faith but without warranty. In view of the many factors that may affect the application, users are recommended to carry out their own trials to determine the suitability of the product for their practical requirements. We cannot accept responsibility for any damage or loss resulting from the use of this information.



TECHNICAL DATA SHEET Chopped Strand Mat, Emulsion Bonded (CSM E.B)

【 Product Description 】

E glass or TCR glass Chopped Strand Mat is made of chopped fiber in specified length randomly & evenly distributed on conveyor, bonded by emulsion binder and cut into certain widths & lengths after heat forming.

It is applicable for hand lay-up, filament winding, compression molding, machine molding process, etc. Compatible with Unsaturated Polyester (UP) & Vinyl resin systems.

It is typically used to produce translucent panels, boat hulls, automobile interior parts, etc.

【 Characteristics 】

Even thickness and medium rigidity
Excellent strand distribution
Fast wet out and low resin consumption
Optimum molding performances
Good mechanical properties

【 Product Code 】

eg. EMCL450-1270M
E E Glass
MCL CSM, Emulsion Bonded
450 Area Weight (g/m²)
1270 Width (mm)
M One edge trimmed

【 Technical Data 】

Product Code	Width (mm)	Area Weight (g/m ²)	Wet Out (s)	Styrene Solubility [s]	Moisture Content %	Binder Type
EMCL	150-2540	100-900	≤180	≤40	≤0.40	PVAc Emulsion

【 Packaging 】

CSM E.B is packed in thermoplastic or PE bags by rolls, separately put into cartons and stacked on the pallet. Each pallet stacks 12 rolls vertically or 9 or 6 rolls horizontally. All pallets should not be stacked in more than 2 layers and cartons not more than 5 layers.

【 Storage 】

This product should be stored in a dry, ventilated and rainproof place, with temperatures 5-35°C and humidity 35-65%. It is recommended to be consumed within 6 months after material delivery and shall be kept in intact package when not used to avoid damp.



Ocpol 402-FR

Ocpol 402 is a fire retardant, thixotropic-accelerated unsaturated isophthalic polyester gelcoat resin. It imparts excellent durability and chemical resistant and can be used in tropical climates. The fire retardant properties makes it suitable for such applications. It is also used for the top coat of the laminate.

Recommendation for Laminating:

Parts by weight:

Ocpol 402-FR	100
Catalyst K 10	2 ml

Applications:

- To start the curing reaction, take 100 parts of gelcoat resin.
- Catalyst K 10 should be added to the resin system shortly before application to initiate the polymerization reaction.
- It is important to add the catalyst in carefully measured amounts to control the polymerization. Too much catalyst will cause too rapid a gelation time, whereas too little catalyst will result in under cure.
- Care must be taken to avoid explosive violence. Do not mix catalyst and cobalt octate or any accelerator together.

Properties of Liquid Resins:

Appearance	Cloudy
Color	Pinkish
Viscosity at 25°C (Brook field, sp. 5@ 2.5 rpm)	40,000-55,000
Gel Time at 25°C	10 - 15
Peak Exotherm Temp°C	180 min.
Acid value mg KOH/g	20±2
Solid content %	65±2
Specific Gravity at 25°C	1.10-1.12



Properties of fully cured resins (unfilled casting):

Barcol hardness (Model GYZJ 934 – 1)	41 - 43
Water absorption 24 h at 23°C	16-18 mg
Elongation at break at 20°C	2.8 – 3.0%

Packing:

Oopol 402-FR is supplied in 220 Kg new steel drums with close top and open top.

Safety:

Due attention should be given to the precautions for handling chemicals provided in our Material Safety Data Sheet.

Remarks:

The information submitted in this publication is given in good faith but without warranty. In view of the many factors that may affect the application, users are recommended to carry out their own trials to determine the suitability of the product for their practical requirements. We cannot accept responsibility for any damage or loss resulting from the use of this information.



Luperox®K1S

Methyl ethyl ketone peroxide

CAS Nr. : 1338-23-4

EINECS : 215-661-2

Luperox K1S is a standard methyl ethyl ketone peroxide used for the cold cure of unsaturated polyester resins at room temperatures in combination with a cobalt accelerator.

Chemical structure

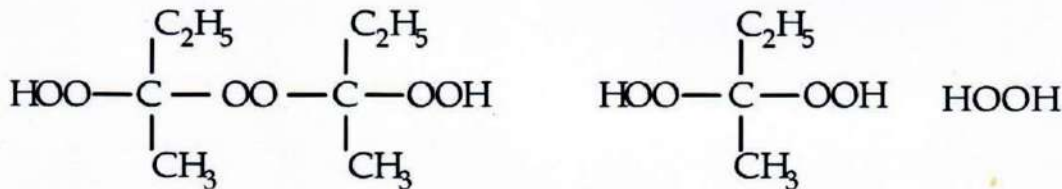

Standard sales specifications

Standard characteristics	Method of analysis	Unit	Specification limits
Physical form	AM/I/71/A	-	Clear liquid
Active oxygen	AM/I/53/C	% w	9.0 - 9.4

p 1/2

Erreur ! Source du renvoi introuvable.	Erreur ! Source du renvoi introuvable.	Rev : Erreur ! Source du renvoi introuvable.	Date : Erreur ! Source du renvoi introuvable.
--	--	--	---



Crack Treatment by Injection

Method Statement

Preparatory Work :

An analysis should be carried out prior to the injections. The extent of the examination and the type of documentation depend on the nature of the building structure and the cracks as well as on their meaning for the building structure. The moisture content and the crack characteristics (type, course, width, width modification, etc.) must be determined to assess the cause of damage and to select the suitable filling materials.

When putting into place horizontal water stops remove all brittle plaster layers from the injection level area and patch all macro-pore joints and defective brickwork with a quick-drying cement or epoxy putty.

Then make the drill holes taking into consideration the actual nature of the building. In the case of crack injections into brickwork and horizontal water stops, drill the holes into the bricks to ensure that the mechanical packers are fastened tightly. When tightening the packers, make sure that the injection hose can be comfortably connected to the zerk or button head fittings.

Mixing

Empty component A and B into a mixing vessel and mix until homogeneous, observing the safety precautions. The containers are provided according to the required mixing ratio of 1:1 parts by volume. Partial quantities can be measured out in separate vessels by the user. After mixing, fill the material into the pump's feed container, stir briefly and apply within pot life.



Injection Procedure

Apply **injection material** by mean of a single or two-comp. pump. Make sure that only pure **injection material** without any residue from cleaning agents or other foreign matter is injected.

In the case of crack injections, the injection procedure must be continued until the crack is filled completely and the resin can be seen emerging from the adjacent packers.

In the case of horizontal water stops, the injection procedure must be continued until the joints are saturated, thus creating a pore seal, and the resin can be seen emerging from the brickwork into the area of the adjacent packers.

The material's pot life may be reduced due to the inherent heat of the injection pump. As soon as the material in the pump's feed container heats up it must be either used immediately or removed from the pump.

Final Work

As soon as the injection material has cured (approx. 24 hours after the injection) remove the packers and close the drill holes with suitable mineral building materials.



Contractors in: **Water Proofing** (Hot, Cold & Acoustic), Buildings, Tunnels, Bridges Off Shores, Swerage System, Base Lining (Environmental & Land Fill Projects) & All Allied Civil Applications

INJECTION PACKERS & PUMP

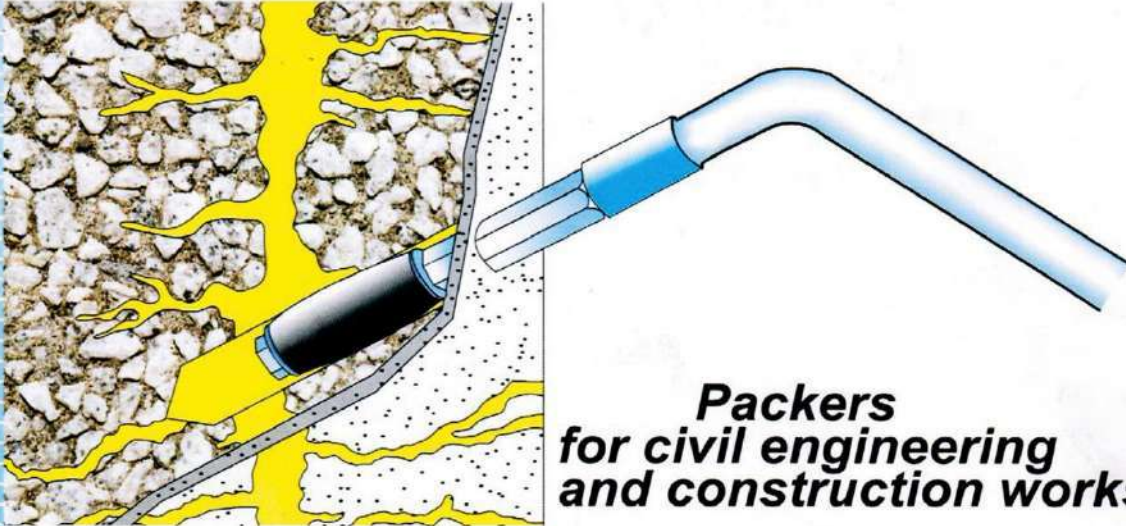





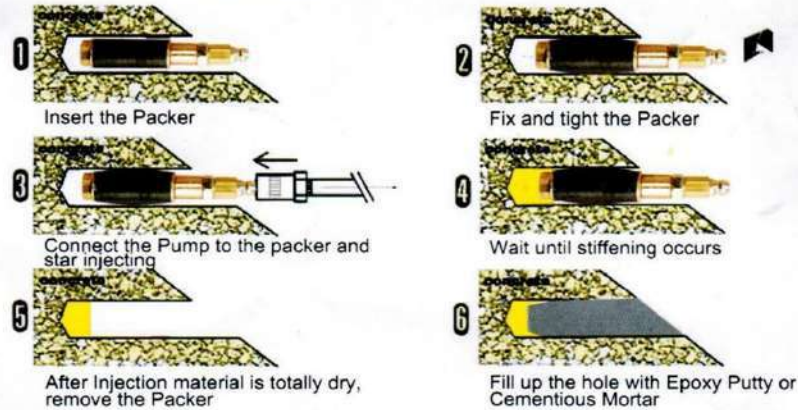

Packers for civil engineering and construction works



STANDARD USAGE OF PACKER



INJECTION PACKERS

	PACKER Ø13mmxL210mm
	PACKER Ø13mmxL150mm
	PACKER Ø13mmxL115mm
	PACKER Ø13mmxL75mm
 IP-66 SURFACE PAKER Round made of plastic Ø 37mm nipple M8x1 straight	 IP-68 SURFACE PAKER Round made of steel Ø 48mm nipple M8x1 straight

ADMIXTURES
FOR
CONCRETE
&
MORTAR

JOINT
SEALANTS

WATER
PROOFING
PRODUCTS

INJECTION
RESINS &
EPOXIES

PROTECTIVE
COATINGS

INDUSTRIAL
FLOORINGS

CEMENTITIOUS
&
MORTARS
&
GROUTS

EPOXY
ADHESIVE
&
MORTARS

CHEMICAL
ANCHORS
&
GROUTS



Contractors in: **Water Proofing** (Hot, Cold & Acoustic), Buildings, Tunnels, Bridges Off Shores, Swerage System, Base Lining (Environmental & Land Fill Projects) & All Allied Civil Applications

Combo Roofing (Multi Layer) System

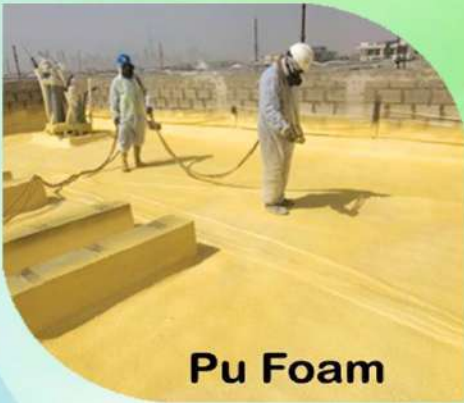



Method Statement of Combo System

- 1) Polyurethane Foam : A layer of Polyurethane Foam 30-40mm Thickness of Average density of 40kg/m³ is spray applied on the slab Substrate after necessary cleaning.
- 2) Liquid Waterproofing : A coat of Rubberize Bituminous liquid water proofing membrane is applied over the Polyurethane Foam.
- 3) Separation Layer : A Layer of 120gsm non-woven Polypropylene geotextile fabric Geo-fabrics will be laid to cover the liquid membrane.
- 4) Slope Lines : Slope lines are made with expansion joint boards anchored with screed to form panels of size 3m x 3m.
- 5) Custom Concrete : Custom concrete will be poured to the laid slope and is then finished smooth. (300 OPC Screed 15N/10)
- 6) Angle Fillets : Angle fillet are now provided along all up stands.
- 7) Expansion Joints : Expansion joints are opened up along the slope lines by grinder.
- 8) Sealant Filling : The joints are now filled with sealant.
- 9) Finishing : The final protective layer will be with an acrylic, Cementitious Waterproofing layer,



Contractors in: **Water Proofing** (Hot, Cold & Acoustic), Buildings, Tunnels, Bridges Off Shores, Sverage System, Base Lining (Environmental & Land Fill Projects) & All Allied Civil Applications

SAMPLE BOARD



1. Polyurethane (35-40) mm

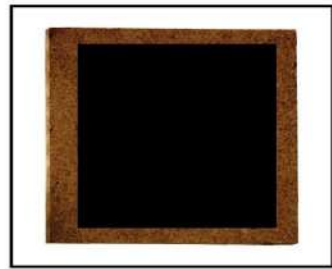

2. Rubberized Coating



3. Geo Textile (Sep Layer)



4. Mortar Bitumen Board



5. Screed in Panels & Slope



6. Cementations / Acrylic Coating

MULTILAYER ROOF SYSTEM

Keeping The Heat Out And Keep Your Frame Cool!



M a t e r i a l U s e d



6. Cementations / Acrylic Coating

5. Screed in Panels & Slope

2. Rubberized Coating

3. Separation Layer

1. Polyurethane (35-40) mm

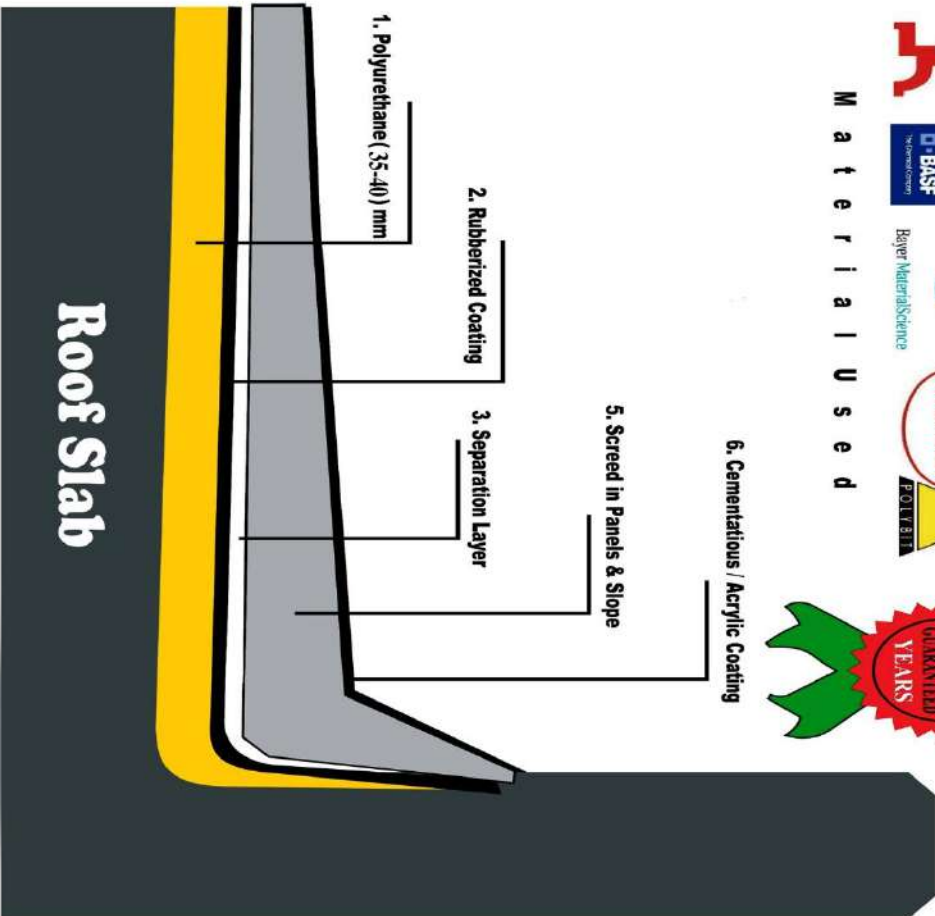

Expansion Joint

1) Seismic Deep Finish Floor Expansion Joint

This series Seismic floor Expansion Joint Cover (Seismic **Gap Cover**) are designed for interior and exterior seismic applications where cover concealment is desired in deeper floor finishes.

The combined use of center bars and compression spring components correctly repositions the pan after seismic movement.

Material of center plate can be aluminum, stainless steel or galvanized iron to meet your requirements.

Location: Floor to Floor, Floor to Wall

Joint Sizes range from 75mm to 500m.

Contact us for larger sizes for custom applications.

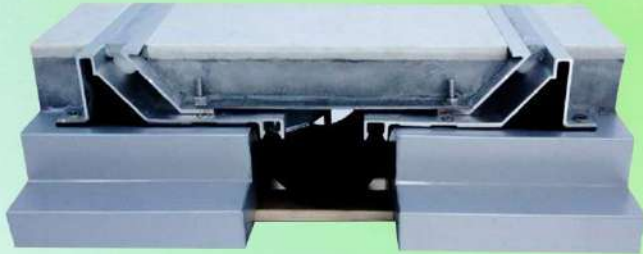

Contractors in: **Water Proofing** (Hot, Cold & Acoustic), Buildings, Tunnels, Bridges Off Shores, Sverage System, Base Lining (Environmental & Land Fill Projects) & All Allied Civil Applications

Performance Data

NOTE: Minimum and maximum openings represent movement criteria only.

Joint Width(W)		75	100	125	150	175	200	250	300	350	400	450	500
Exposed Surface(ES)		285	310	335	360	385	410	460	510	560	610	660	710
Movement Capacity(mm)	Total	60	60	60	60	60	60	60	60	60	60	60	60
	+	30	30	30	30	30	30	30	30	30	30	30	30
	-	30	30	30	30	30	30	30	30	30	30	30	30

Drawing - Section Details

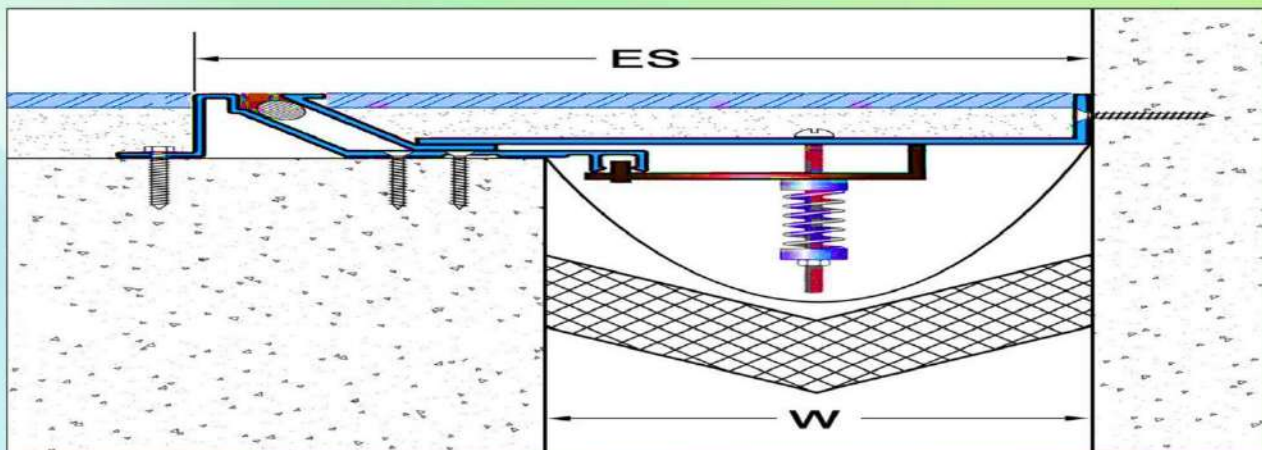
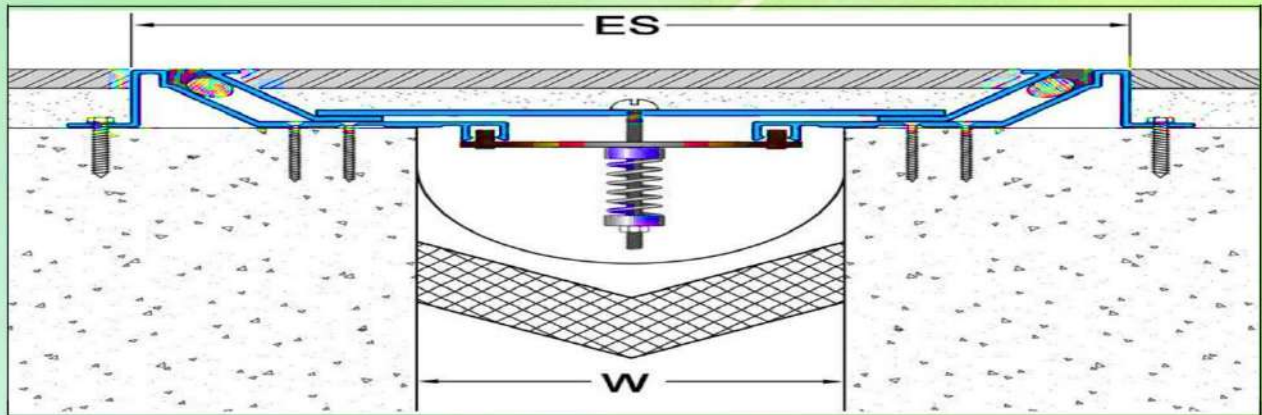

2) Serrated Stainless Steel Floor Expansion Joint Cover Plate FM

FM Series floor expansion joint covers are available with stainless steel cover plate, aluminium cover plate and brass cover plate.

It is designed for normal pedestrian applications such as office buildings, hotels, foyers and hospitals etc.

It can be used in conjunction with many floor finishes, such as tile, timber, concrete, vinyl, adhesive backed carpet tiles and epoxy floors etc. The systems offer various movements in 6 directions.

Location: Floor to Floor, Floor To Wall

Contact us for larger sizes for custom applications.

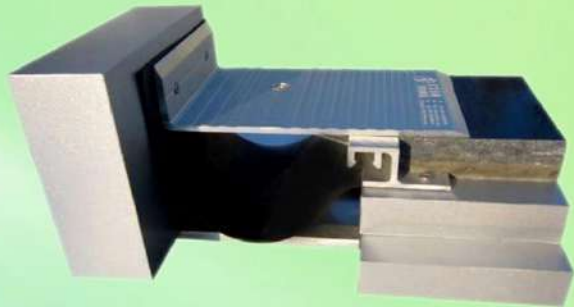
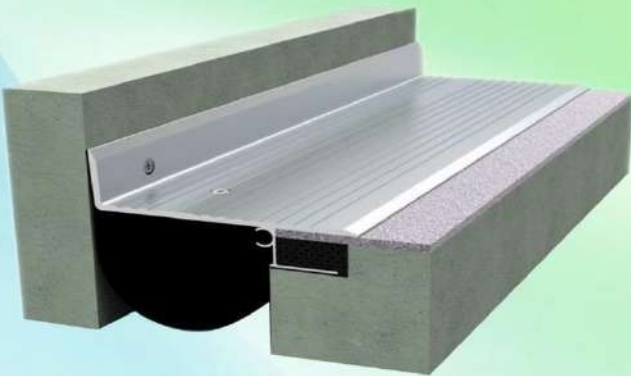



Contractors in: **Water Proofing** (Hot, Cold & Acoustic), Buildings, Tunnels, Bridges Off Shores, Swerage System, Base Lining (Environmental & Land Fill Projects) & All Allied Civil Applications

Performance Data

NOTE: Minimum and maximum openings represent movement criteria only

Joint Width	Exposed Surface	Movement Capacity
75	175	37
100	200	50
125	225	62
150	250	75
200	300	100
250	375	125
300	450	150
350	525	175
400	600	200
450	675	225
500	750	250

Contractors in: **Water Proofing** (Hot, Cold & Acoustic), Buildings, Tunnels, Bridges Off Shores, Swerage System, Base Lining (Environmental & Land Fill Projects) & All Allied Civil Applications

Drawing - Section Details

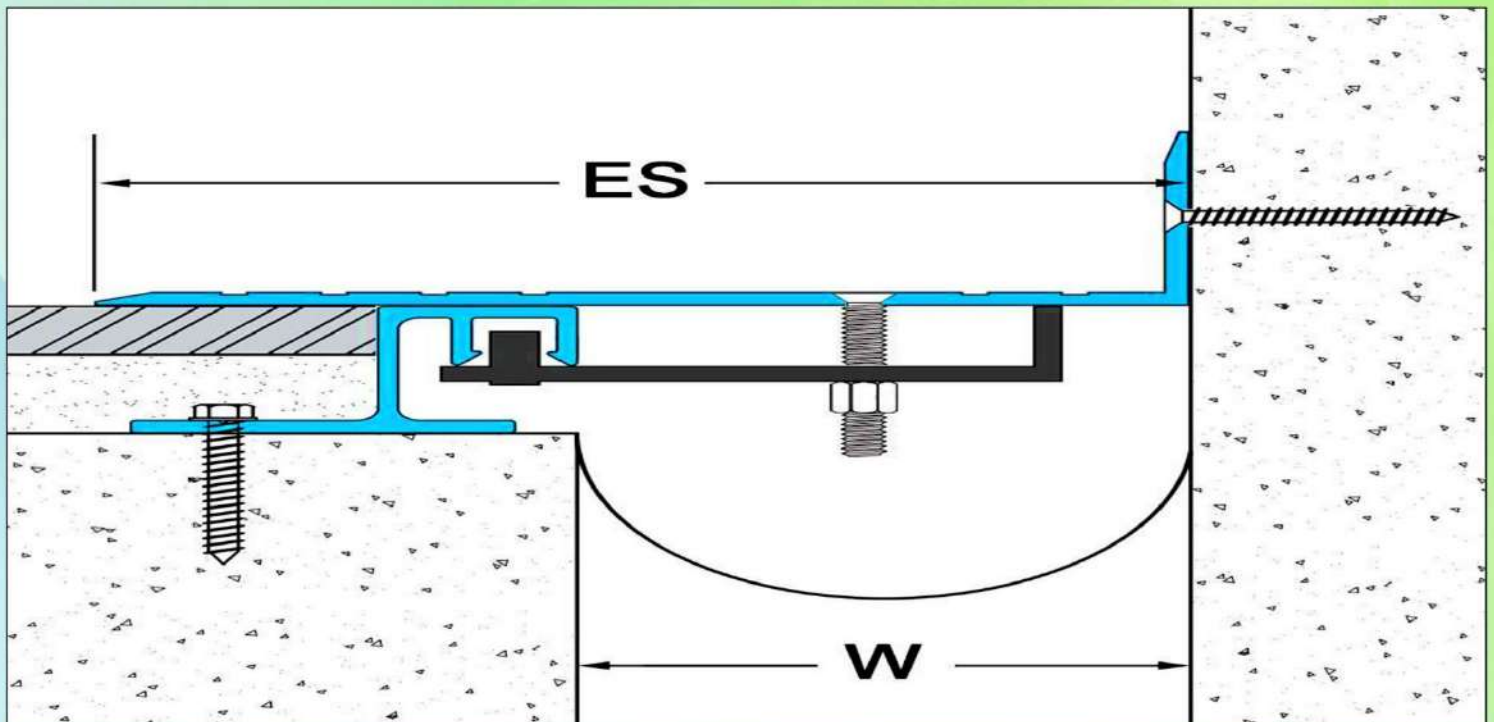
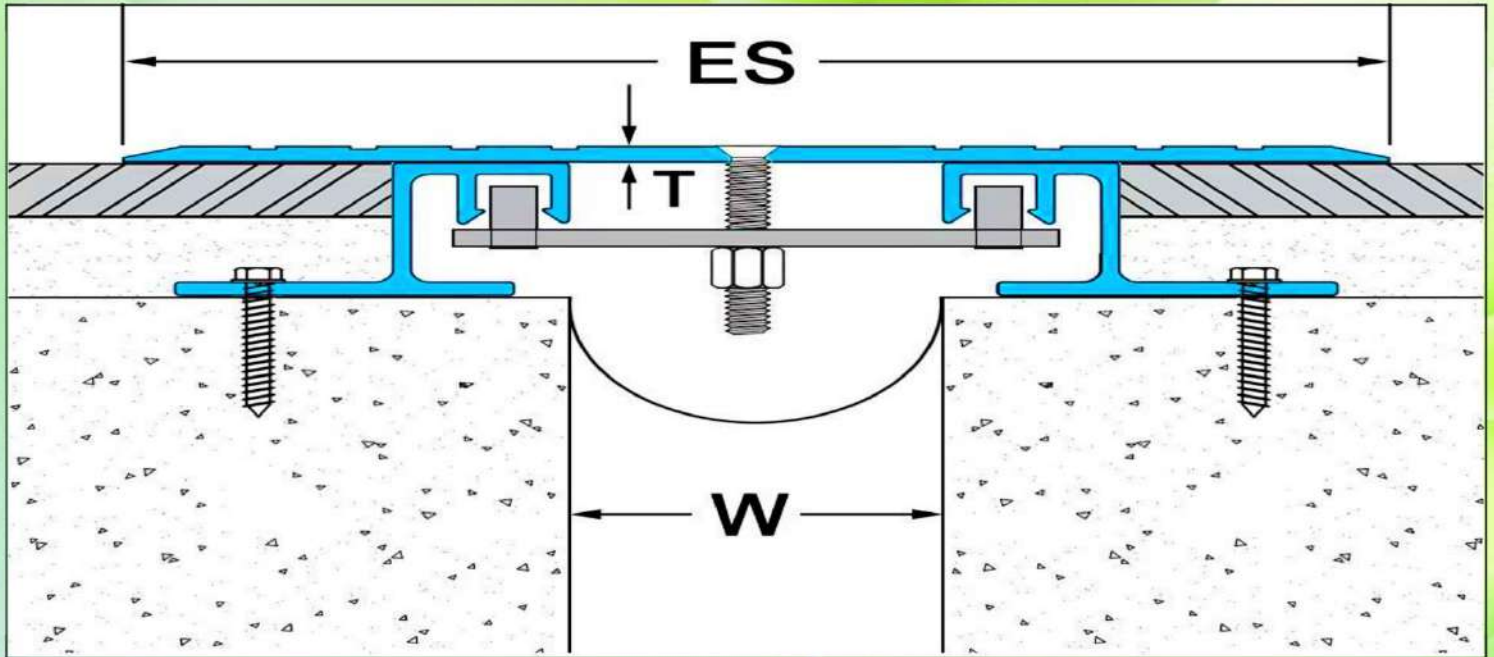

Tahir Amin
INSULATION CONT. LLC



طاهر امين
للمقاومات العزل ذم

Contractors in: **Water Proofing** (Hot, Cold & Acoustic), Buildings, Tunnels, Bridges Off Shores, Swerage System, Base Lining (Environmental & Land Fill Projects) & All Allied Civil Applications



+971 65469744 +971 50 9677832
info@taic.ae, insulation008@gmail.com

www.taic.ae @taicllc2008
completewaterproofingsolution

3) Interior Aluminum Wall Expansion Joint IL1

This is interior wall expansion joint cover / ceiling expansion joint cover, comprised of extruded aluminum components, and rubber gaskets where the cover plates contact adjacent surfaces.

Snap-fit cover design makes for easy on-site install.

No exposed fasteners.

Economical solution for retrofit and surface mount installations.

Clear anodized finish standard.

Optional Kynar, powder coat, and anodized finishes also available.

Custom stainless steel veneer option available

Location: Wall to Wall, Wall to Corner, Ceiling to Ceiling

Optional: Fire Barrier

Joint Sizes range from 25mm to 200mm.

Contact us for larger sizes for custom applications.

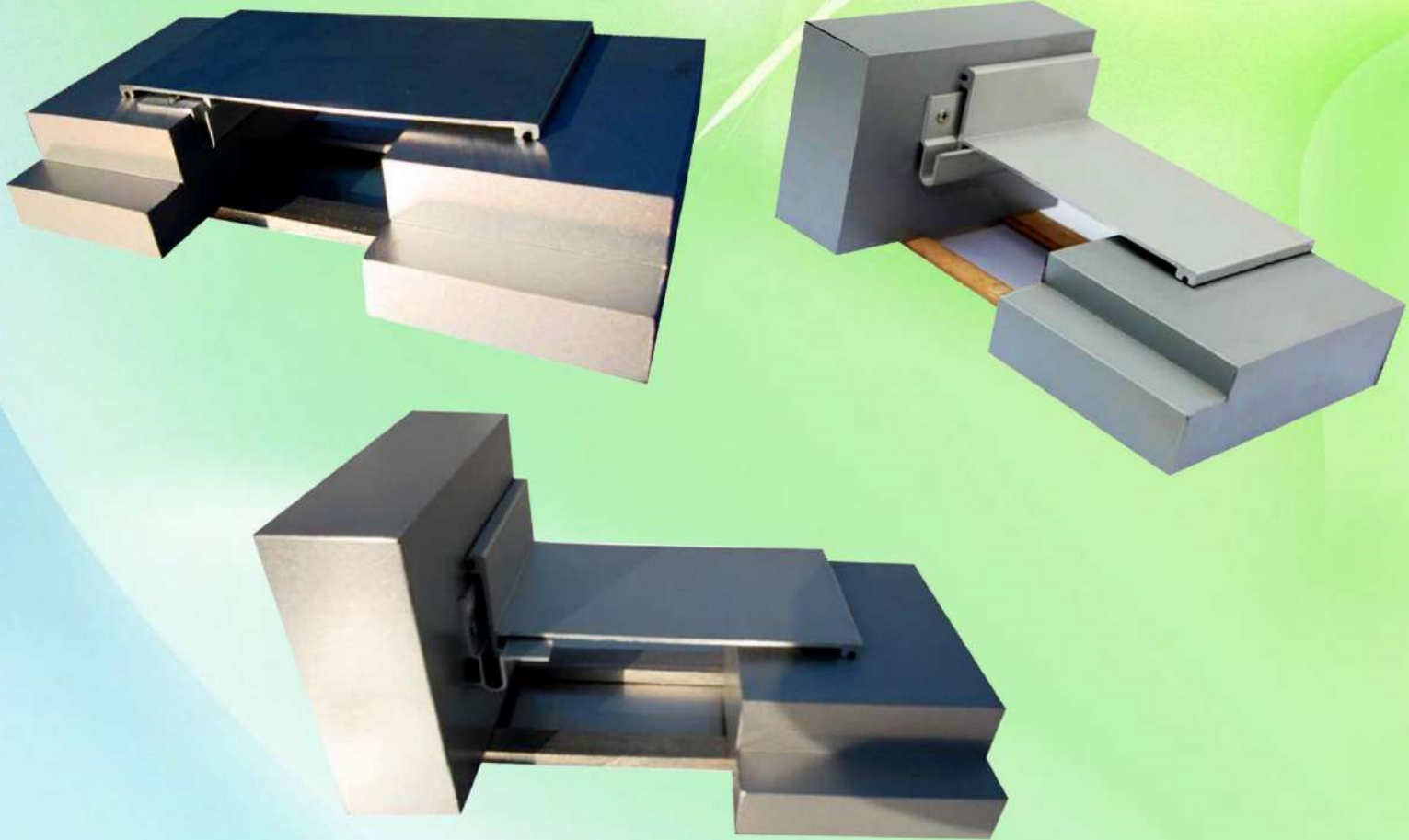



Performance Data

NOTE: Minimum and maximum openings represent movement criteria only

Wall to Wall Ceiling to Ceiling	Joint Width(W)		50	100	150	200
	Exposed Surface(ES)		150	200	250	300
	Movement Capacity(mm)	Total	90	140	190	240
		+	50	50	50	50
		-	40	90	140	190
Wall to Corner	Joint Width(W)		50	100	150	
	Exposed Surface(ES)		100	145	200	
	Movement Capacity(mm)	Total	85	130	185	
		+	50	45	50	
		-	35	85	135	

Drawing - Section Details

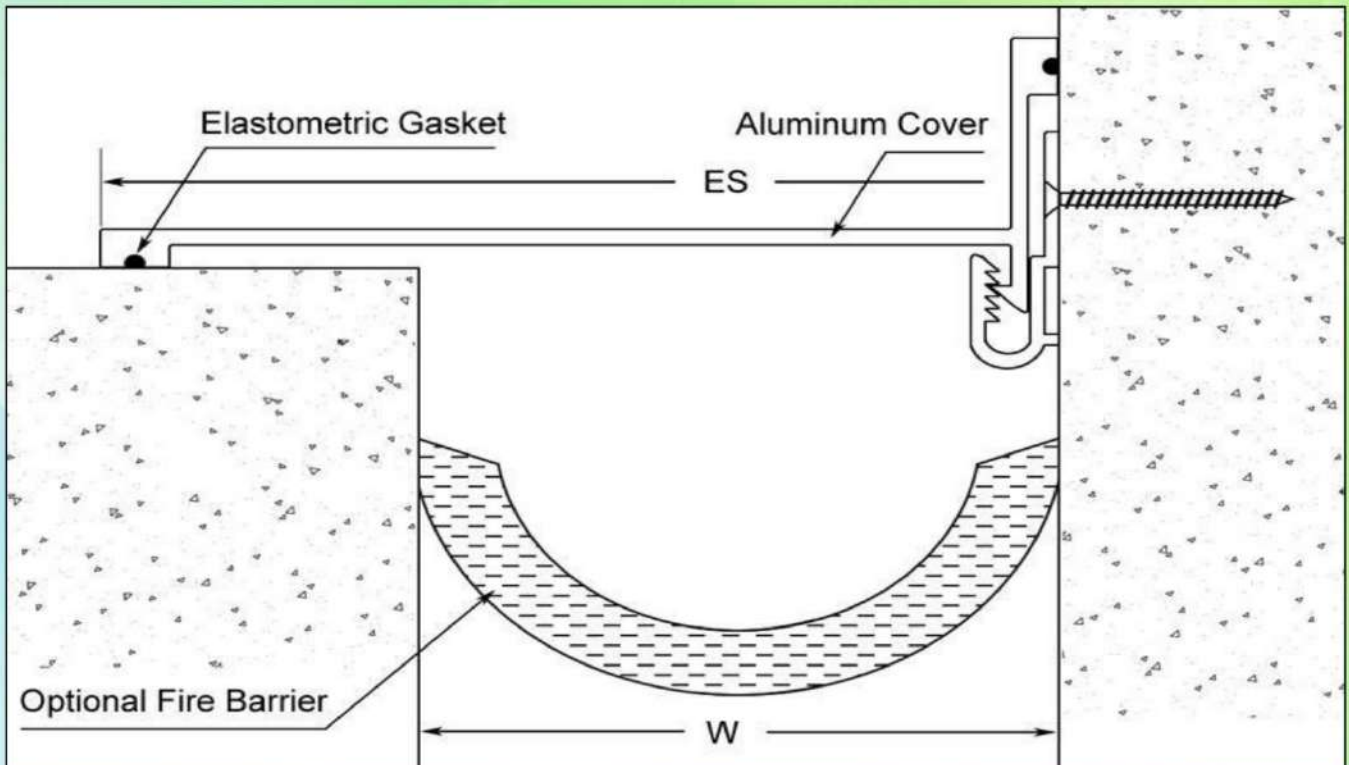
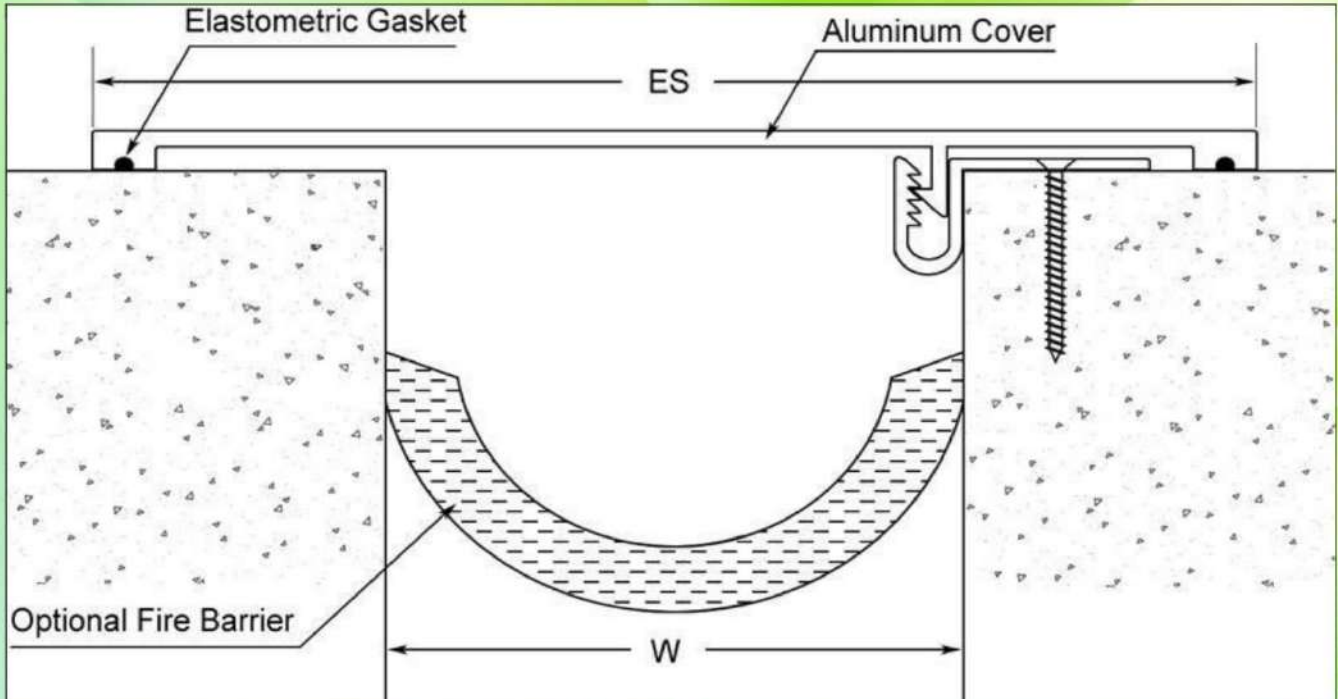

4) Seismic Aluminum Roof Expansion Joint Cover RMF

Aluminum roof covers comprised of extruded aluminum components, designed for seismic applications and ensures a watertight transition where exterior wall seals are installed. The system is available with custom, factory-made transitions to ensure watertight results.

Location: Roof to Roof/Roof to Wall

Easy onsite assembly and installation

Multi-directional seismic movement

Neoprene weather washers prevent leaking where fasteners penetrate frames/covers

Canted curb mount

Plate available in stainless steel

Joint Sizes range from 50mm to 500mm.

Contact us for larger sizes for custom applications.

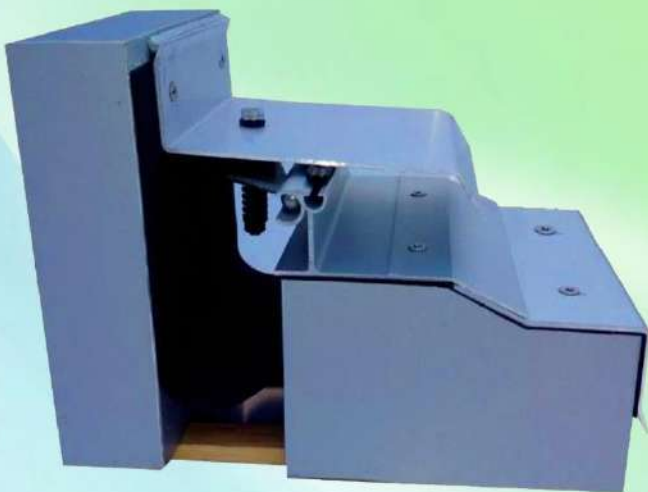
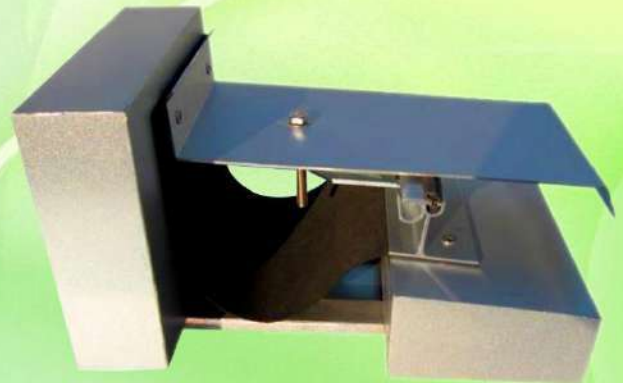

Contractors in: **Water Proofing** (Hot, Cold & Acoustic), Buildings, Tunnels, Bridges Off Shores, Swerage System, Base Lining (Environmental & Land Fill Projects) & All Allied Civil Applications

Performance Data

NOTE: Minimum and maximum openings represent movement criteria only

Roof to Roof	Joint Width(W)		50	75	100	125	150	200	250	300	350	400	450	500
	Exposed Surface(ES)		230	255	280	305	330	380	430	480	530	580	630	680
	Movement Capacity(mm)	Total	170	195	220	245	270	320	370	420	470	520	570	620
		+	140	140	140	140	140	140	140	140	140	140	140	140
	-	30	55	80	105	130	180	230	280	330	380	430	480	
Roof to Wall	Joint Width(W)		50	75	100	125	150	200	250	300	350	400	450	500
	Exposed Surface(ES)		150	175	200	225	250	300	350	400	450	500	550	600
	Movement Capacity(mm)	Total	110	135	160	185	210	260	310	360	410	460	510	560
		+	80	80	80	80	80	80	80	80	80	80	80	80
	-	30	55	80	105	130	180	230	280	330	380	430	480	

Drawing - Section Detail

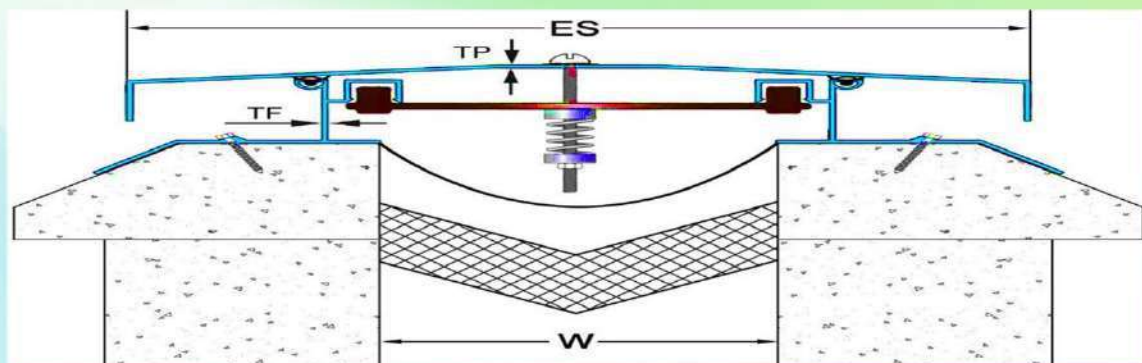
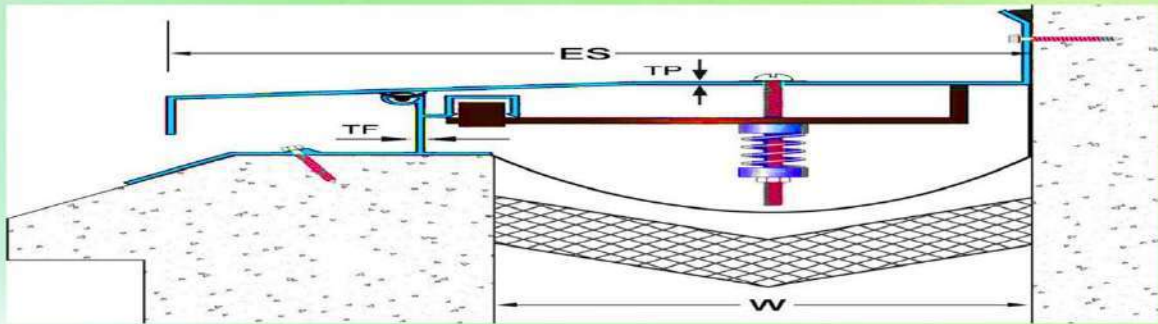

5) Flush Aluminum Wall Expansion Joint IL2

Flush aluminum wall cover for different wall finishes.

Designed for interior wall, ceiling and exterior wall.

Recessed frame is designed for drywall installations or surface mounted.

Snap-fit cover design makes for easy on-site install.

No exposed fasteners.

Joint Sizes range from 25mm to 500mm.

Contact us for larger sizes for custom applications.

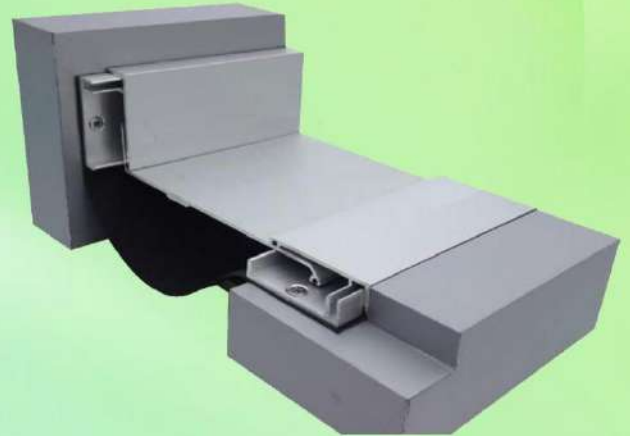
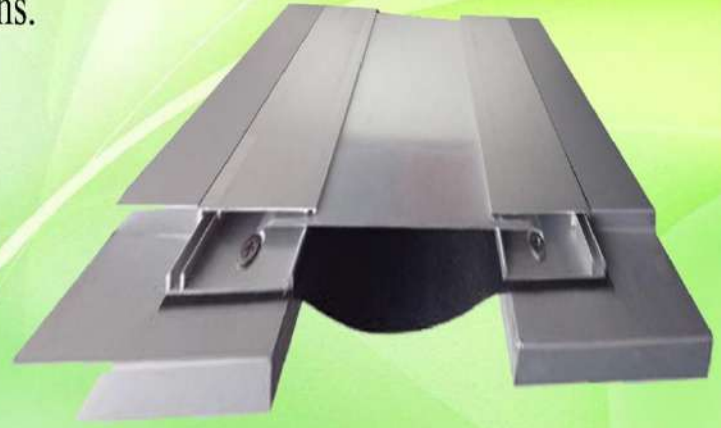



Contractors in: **Water Proofing** (Hot, Cold & Acoustic), Buildings, Tunnels, Bridges Off Shores, Swerage System, Base Lining (Environmental & Land Fill Projects) & All Allied Civil Applications

Performance Data

NOTE: Minimum and maximum openings represent movement criteria only

Model: W-W	Joint Width(W)	25	50	75	100	125	150	175	200	250	300	350	400	350	500	
	Exposed Surface(ES)	120	145	170	195	220	245	270	295	340	390	440	490	540	590	
	Movement Capacity(m m)	To tal	80	80	80	80	80	80	80	80	80	80	80	80	80	80
		+	40	40	40	40	40	40	40	40	40	40	40	40	40	40
-		40	40	40	40	40	40	40	40	40	40	40	40	40	40	
Model: W-C	Joint Width(W)	25	50	75	100	125	150	175	200	250	300	350	400	450	500	
	Exposed Surface(ES)	75	100	125	150	175	200	225	250	300	350	400	450	500	550	
	Movement Capacity(m m)	To tal	40	40	40	40	40	40	40	40	40	40	40	40	40	40
		+	20	20	20	20	20	20	20	20	20	20	20	20	20	20
-		20	20	20	20	20	20	20	20	20	20	20	20	20	20	



Contractors in: **Water Proofing** (Hot, Cold & Acoustic), Buildings, Tunnels, Bridges Off Shores, Swerage System, Base Lining (Environmental & Land Fill Projects) & All Allied Civil Applications

Drawing - Section Details

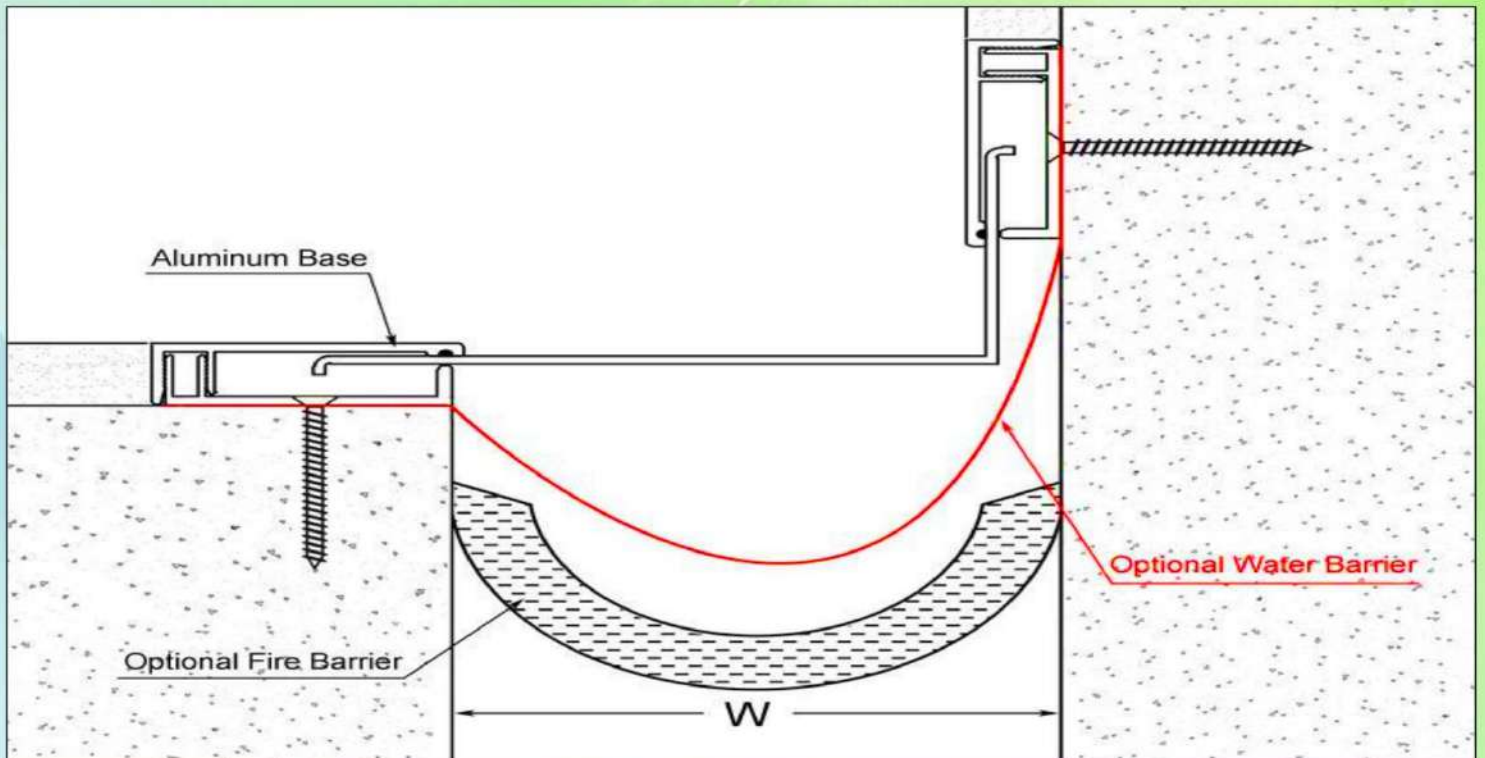
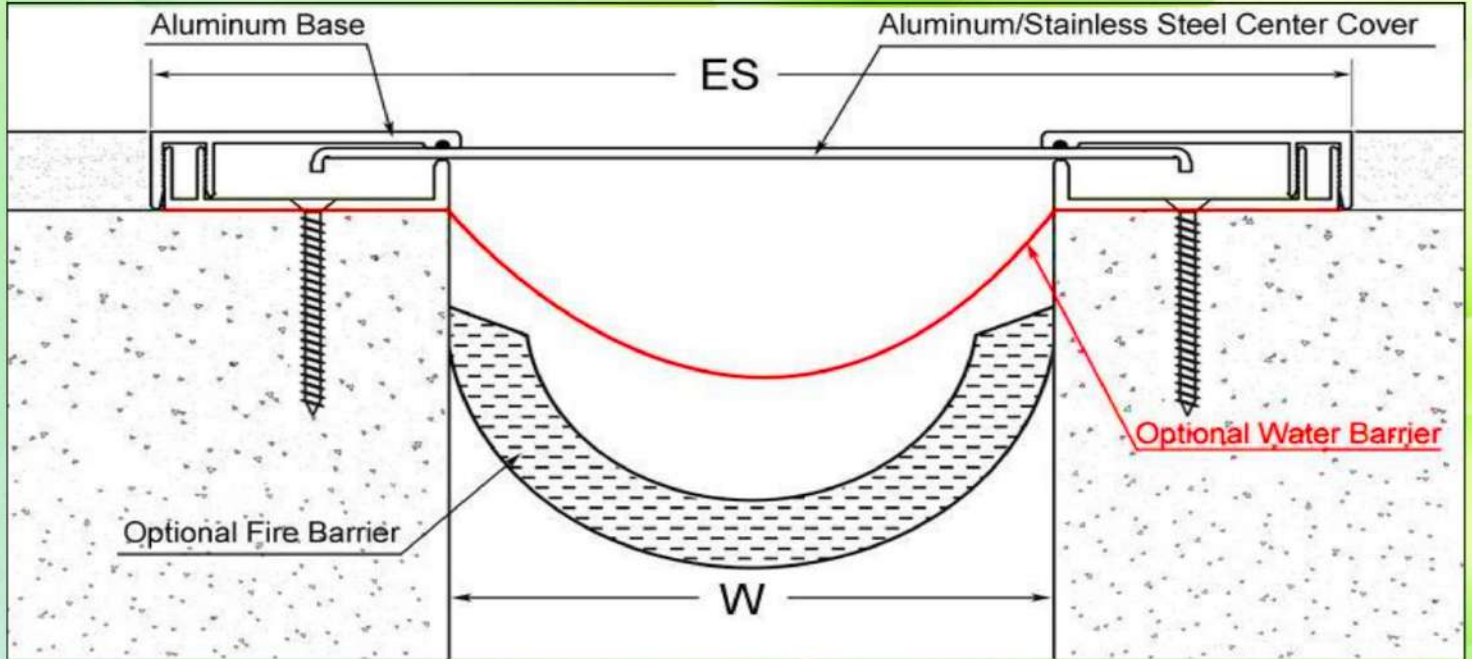

6) Flush Heavy Duty Floor Expansion Joint Cover FDM

FDM series heavy duty floor expansion joint cover are designed for conditions requiring heavy duty loads such as car parks, driveways and roof top parking structures.

Featuring a high load bearing system.

Optional stainless steel center cover plate/aluminum center cover plate

Joint Sizes range from 100mm to 300mm.

Location: Floor to Floor / Floor to Wall designed for car parks, driveways and roof top parking structures

Contact us for larger sizes for custom applications.

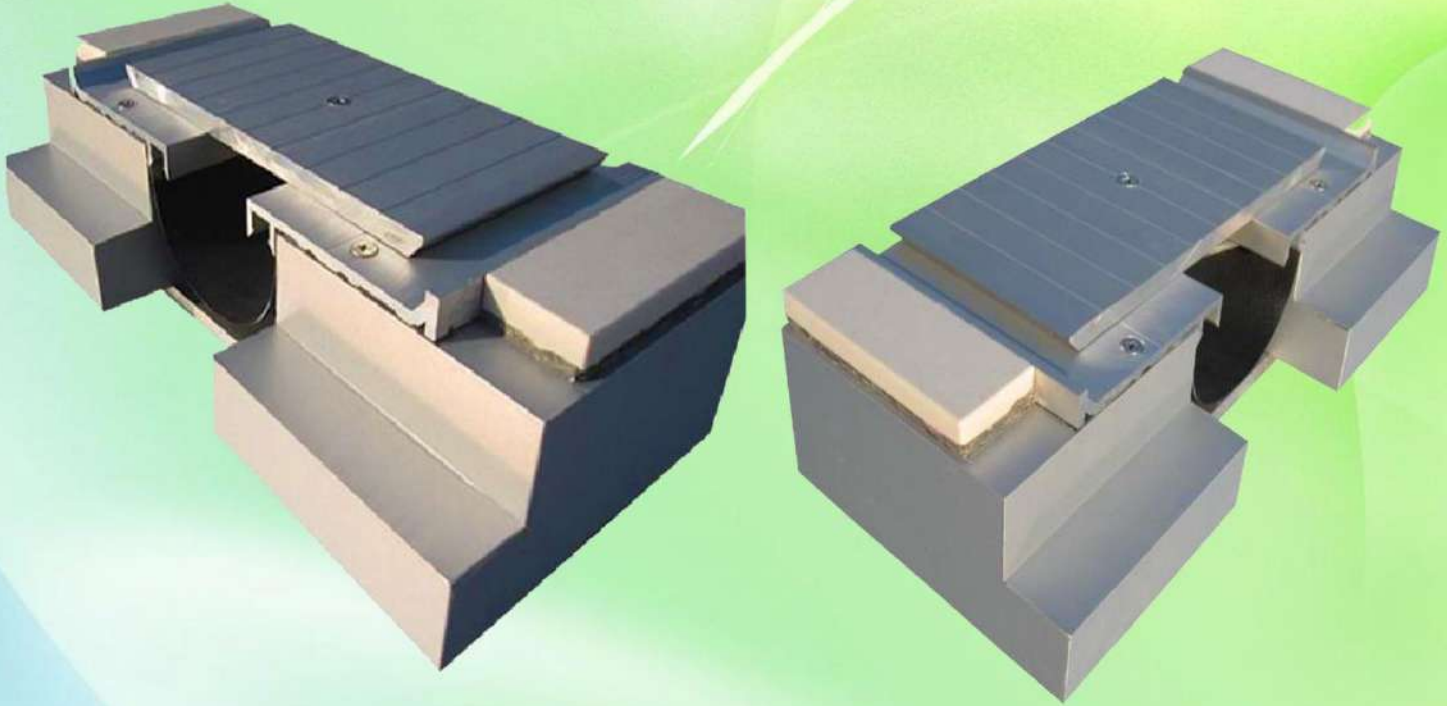

Performance Data

NOTE: Minimum and maximum openings represent movement criteria only

Joint Width(W)	75	100	125	150	200	250	300
Exposed Surface(ES)	229	254	279	304	354	404	454
Movement Capacity(mm)	80	80	80	80	80	80	80

Drawing - Section Details

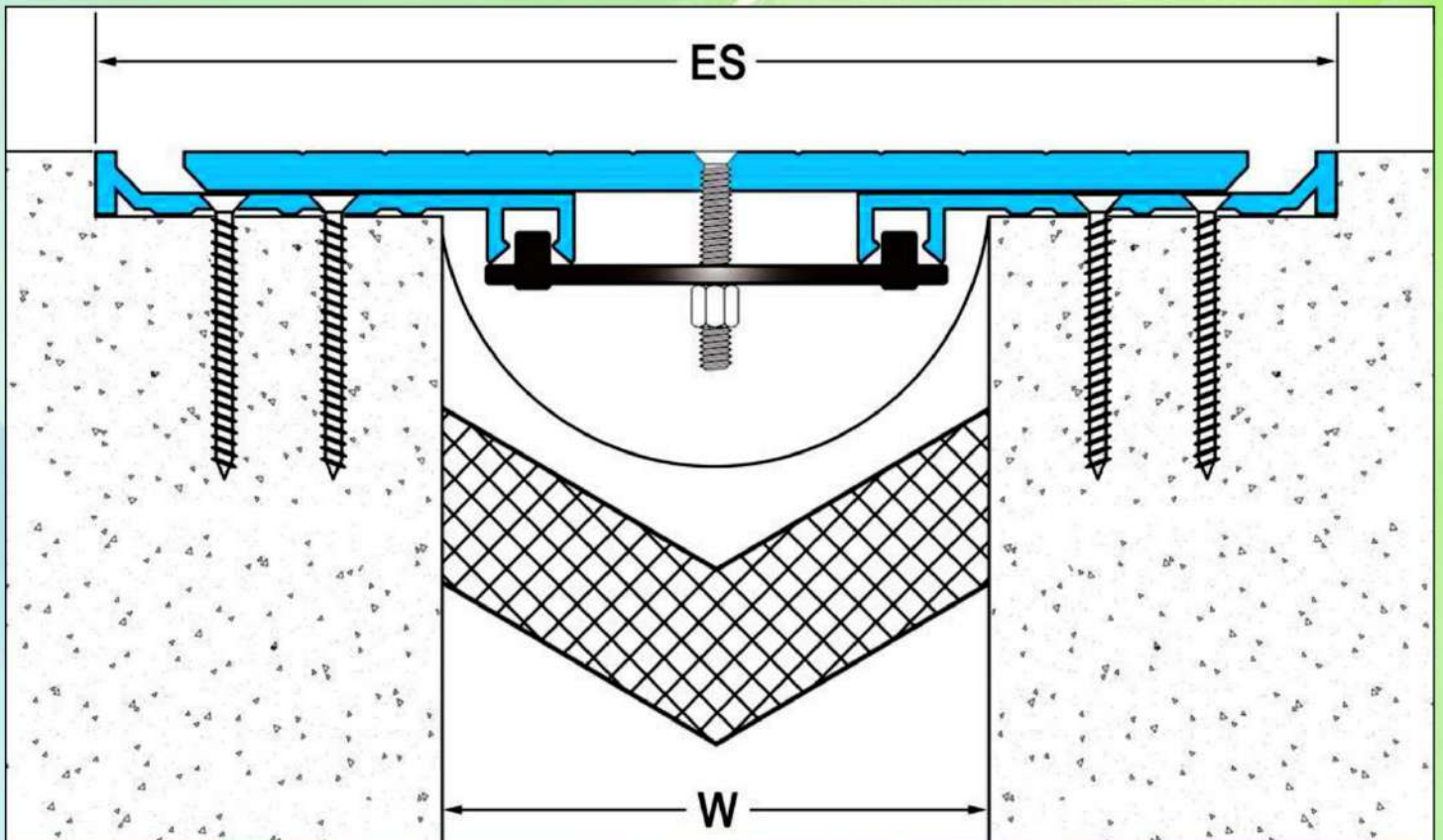

7) Pleated Santoprene Seal Flush Mount Wall Expansion Joint

Flush mount interior and exterior systems reduce sightline

TPV seals(same to Santoprene seals) - good tear resistance and suitable hardness, field heat weldable for weather tight transitions

Location: Wall to Wall, Ceiling to Ceiling, Wall to Corner etc.

Color: Black, Grey, Binge, Yellow etc.

Contact us for larger sizes for custom applications.

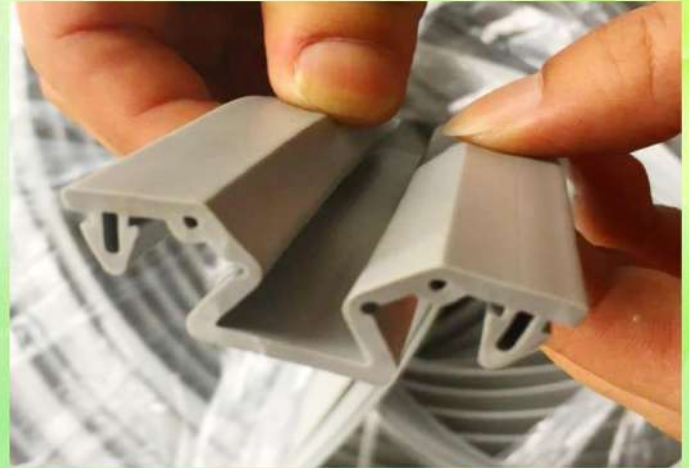

Contractors in: **Water Proofing** (Hot, Cold & Acoustic), Buildings, Tunnels, Bridges Off Shores, Swerage System, Base Lining (Environmental & Land Fill Projects) & All Allied Civil Applications

Performance Data

NOTE: Minimum and maximum openings represent movement criteria only

Joint Width(MM)	Exposed Surface(MM)	Movement Capacity(MM)
50	50	±25
75	75	±37
100	100	±50
125	125	±62
150	150	±75

Drawing - Section Details

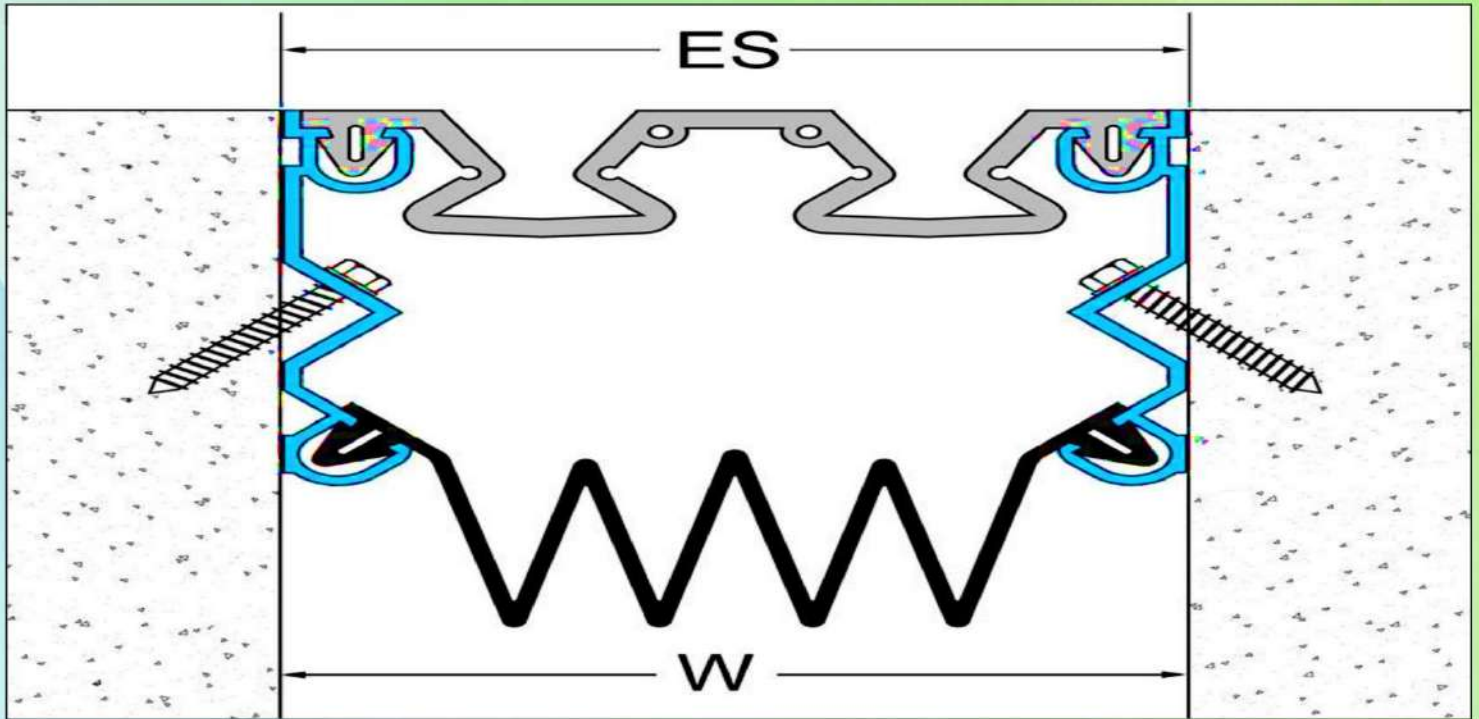

8) Stainless Steel Tile Movement Joint

Stainless Steel Tile Movement Joints are designed for porcelain tile, ceramic tile, marble, material can be SS 304 or SS 201.

Applications: Vertical and horizontal applications, floors and cladding;

Interior and exterior surfaces;

Retail, factories, schools and commercial applications where large areas of tile, stone or wood are common installations

Contact us for larger sizes for custom applications.

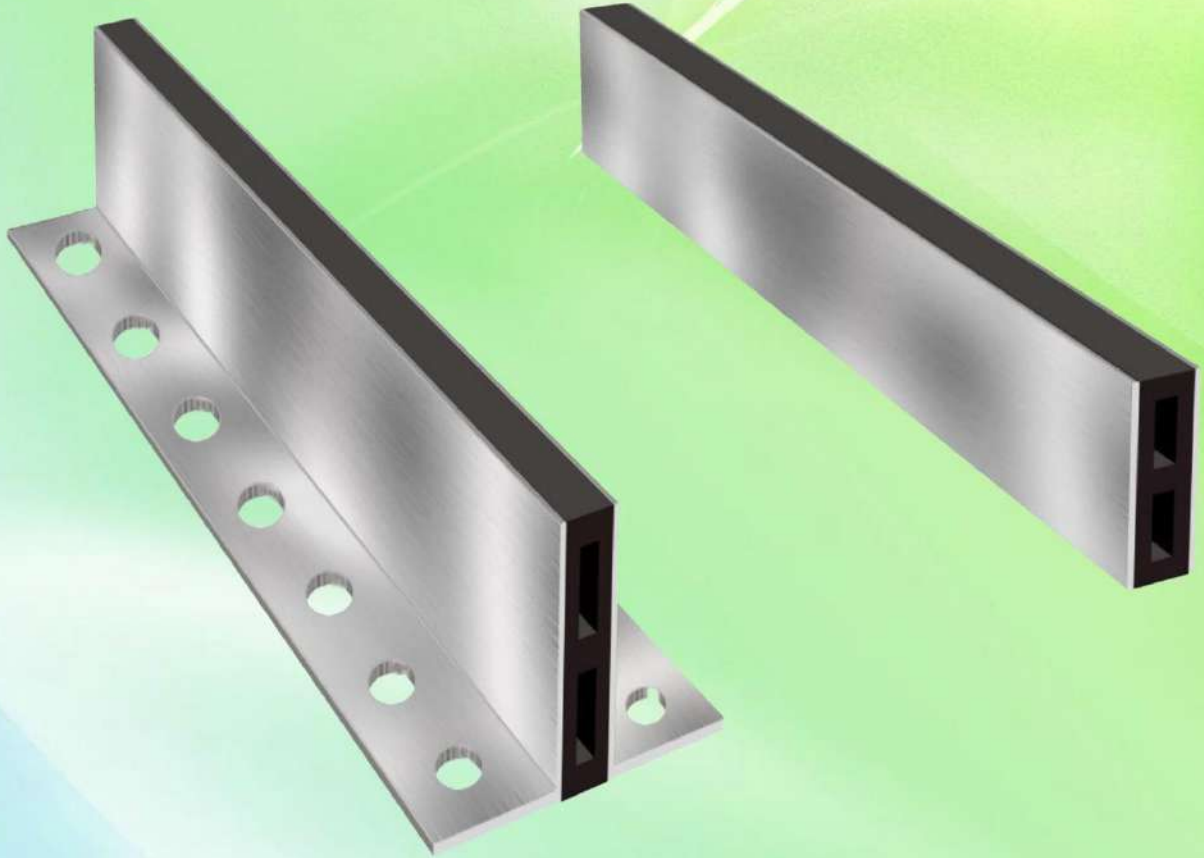



Contractors in: **Water Proofing** (Hot, Cold & Acoustic), Buildings, Tunnels, Bridges Off Shores, Swerage System, Base Lining (Environmental & Land Fill Projects) & All Allied Civil Applications

Performance Data

NOTE: Minimum and maximum openings represent movement criteria only

Model	Exposed Surface	Total Width	Movement Capacity	Height
FCT-SS-101850	10	50	2	18
FCT-SS-102050	10	50	2	20
FCT-SS-102250	10	50	2	22
FCT-SS-102550	10	50	2	25
FCT-SS-103050	10	50	2	30
FCT-SS-103550	10	50	2	35
FCT-SS-104050	10	50	2	40
FCT-SS-105050	10	50	2	50
FCI-SS-1010	10	10	2	10
FCI-SS-1020	10	10	2	20
FCI-SS-1030	10	10	2	30



Contractors in: **Water Proofing** (Hot, Cold & Acoustic), Buildings, Tunnels, Bridges Off Shores, Swerage System, Base Lining (Environmental & Land Fill Projects) & All Allied Civil Applications

FCI-SS-1040	10	10	2	40
FCI-SS-1050	10	10	2	50
FCI-SS-1060	10	10	2	60
FCI-SS-1070	10	10	2	70
FCI-SS-1080	10	10	2	80
FCI-SS-1090	10	10	2	90
FCI-SS-10100	10	10	2	100
FCM-SS-101830	10	30	2	18
FCM-SS-102030	10	30	2	20
FCM-SS-102230	10	30	2	22
FCM-SS-102530	10	30	2	25
FCM-SS-103030	10	30	2	30
FCM-SS-103530	10	30	2	35
FCM-SS-104030	10	30	2	40
FCM-SS-105030	10	30	2	50



Contractors in: **Water Proofing** (Hot, Cold & Acoustic), Buildings, Tunnels, Bridges Off Shores, Sverage System, Base Lining (Environmental & Land Fill Projects) & All Allied Civil Applications

Drawing - Section Details

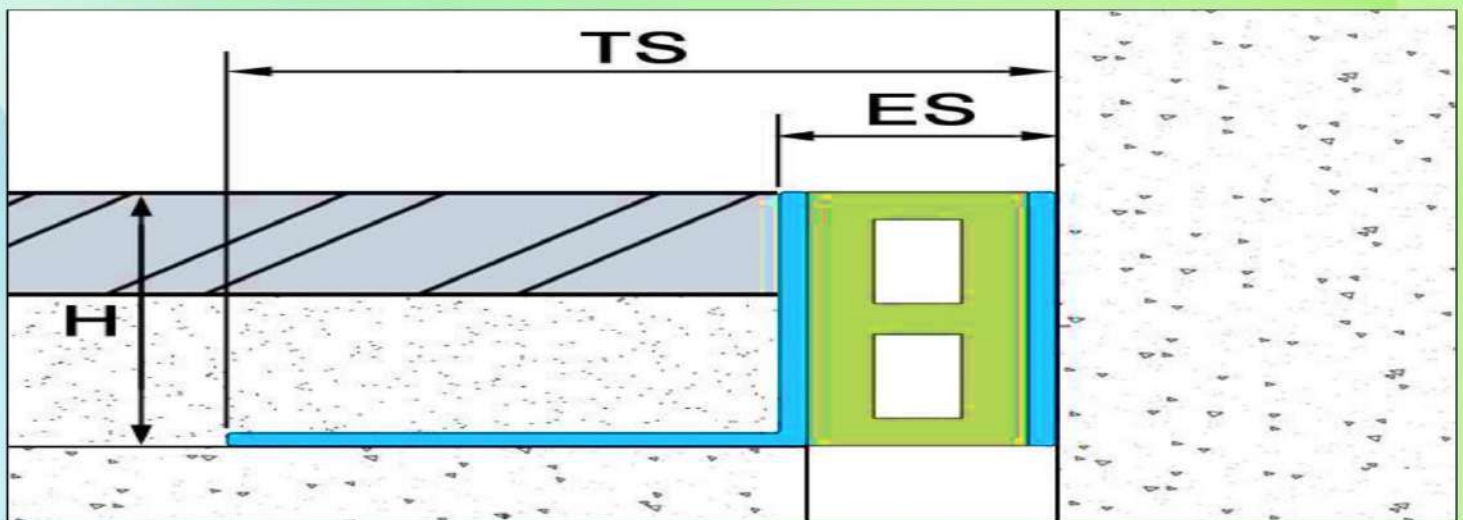
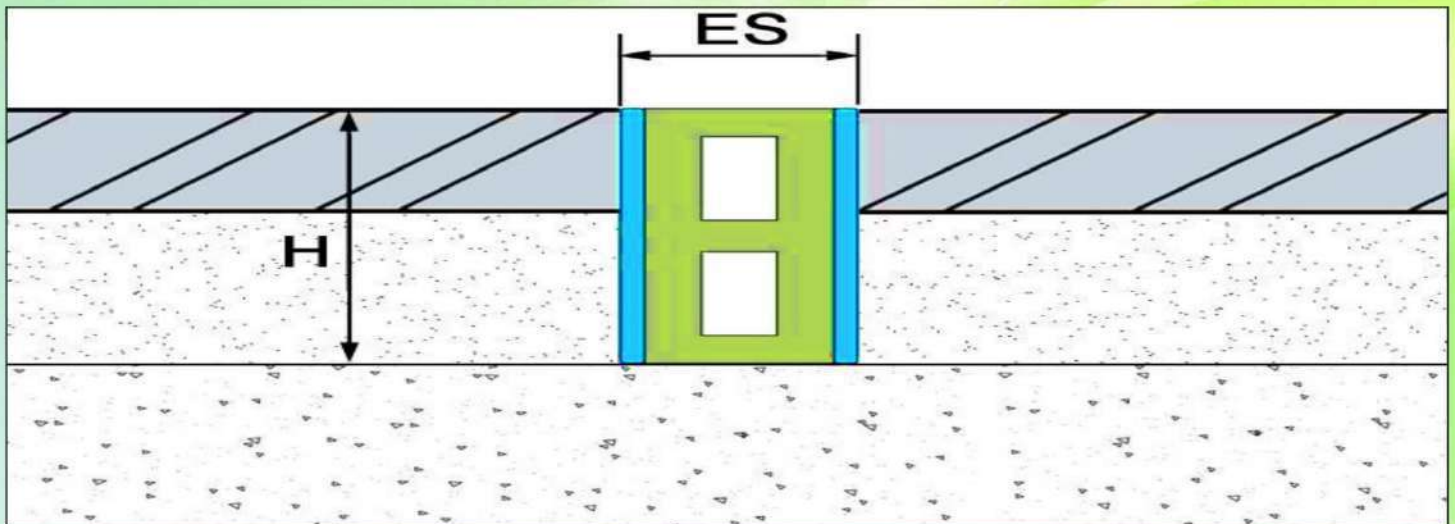
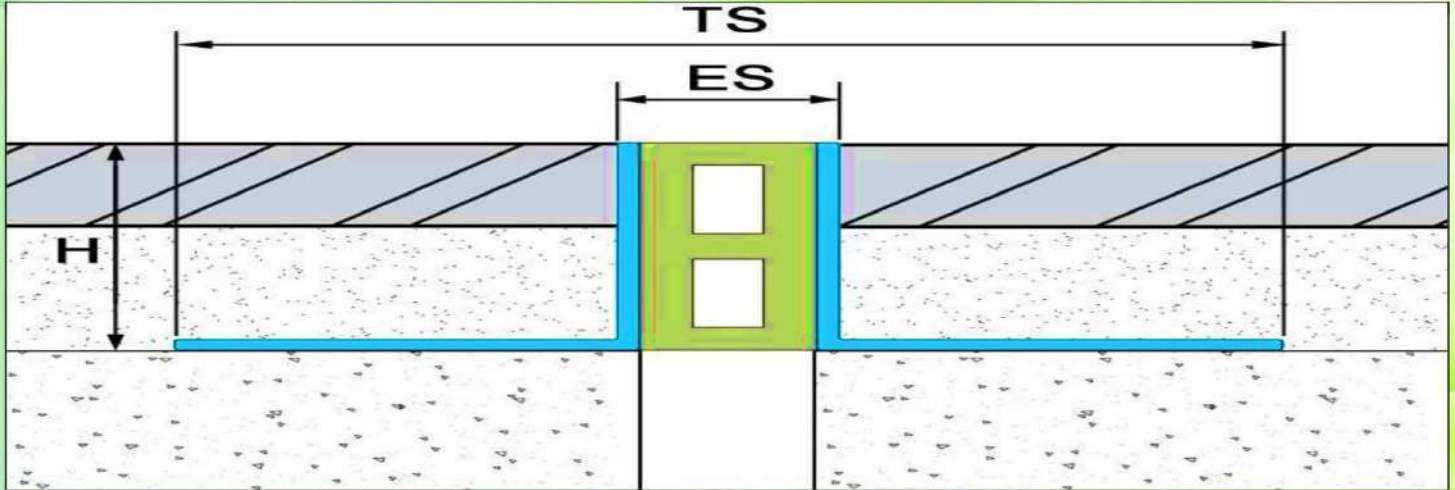

9) Flush ThinLine / Single Seal Floor Expansion Joint

This flush single Santoprene seal floor expansion joint cover is ideal for interior applications where minimal visual impact is desired.

Easy to clean flush seals

No dirt or water traps.

This cover is adaptable to many finishes, including ceramic tile, marble, stone, vinyl, tile and carpet.

It is available in multiple frame heights.

Floor To Floor, Floor To Wall Conditions

Joint sizes range from 25MM to 50MM.

Contact us for larger sizes for custom applications.

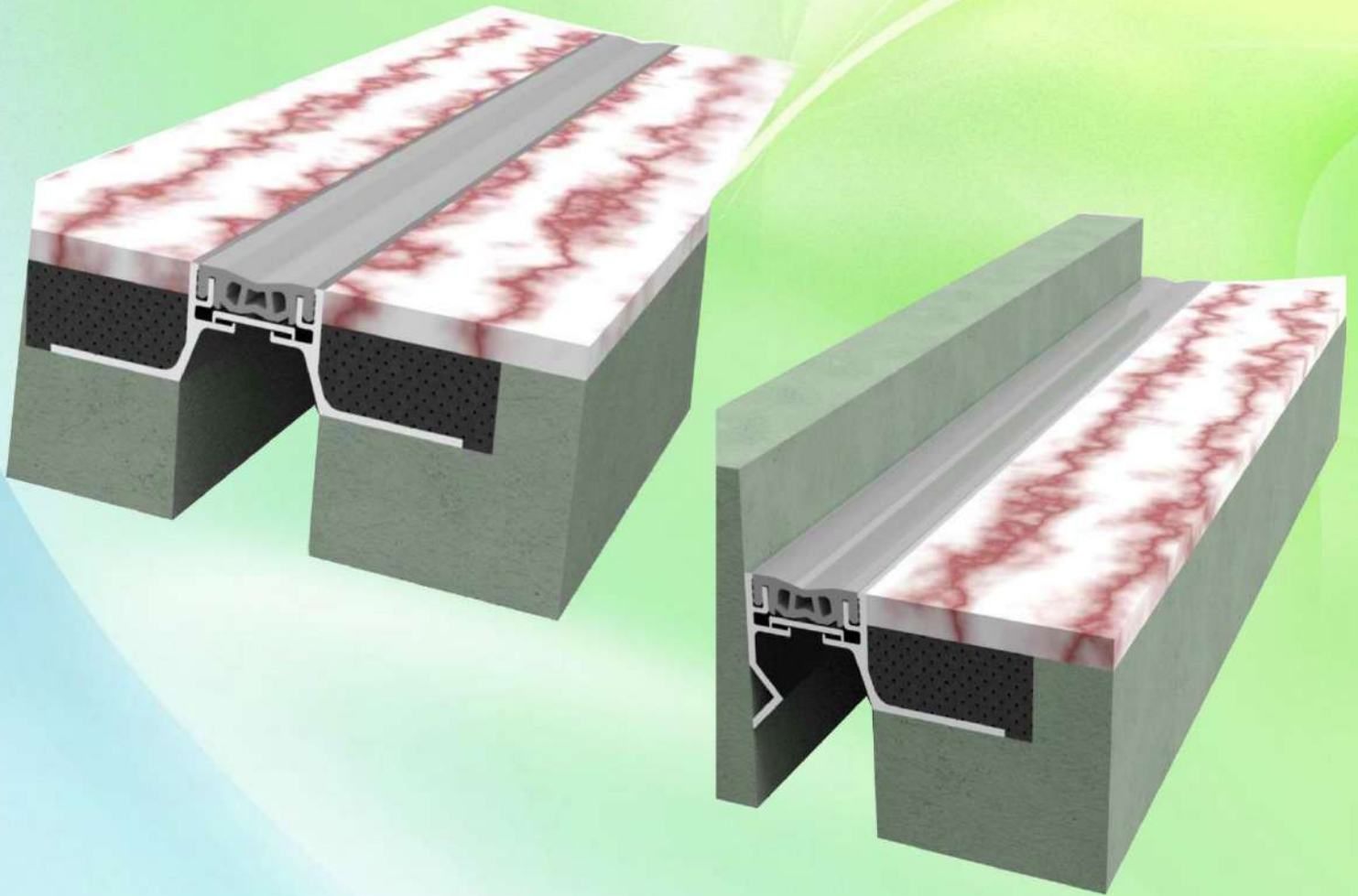

Performance Data

NOTE: Minimum and maximum openings represent movement criteria only

Model(MM)	Joint Width(MM)	Minimum Opening(MM)	Maximum Opening(MM)	Exposed Surface(MM)
FRGXA-25	25	19	32	32
FRGXA-50	50	38	63	48
F-WRGXA-25	25	19	32	29
F-WRGXA-50	50	38	63	49

Drawing - Section Details

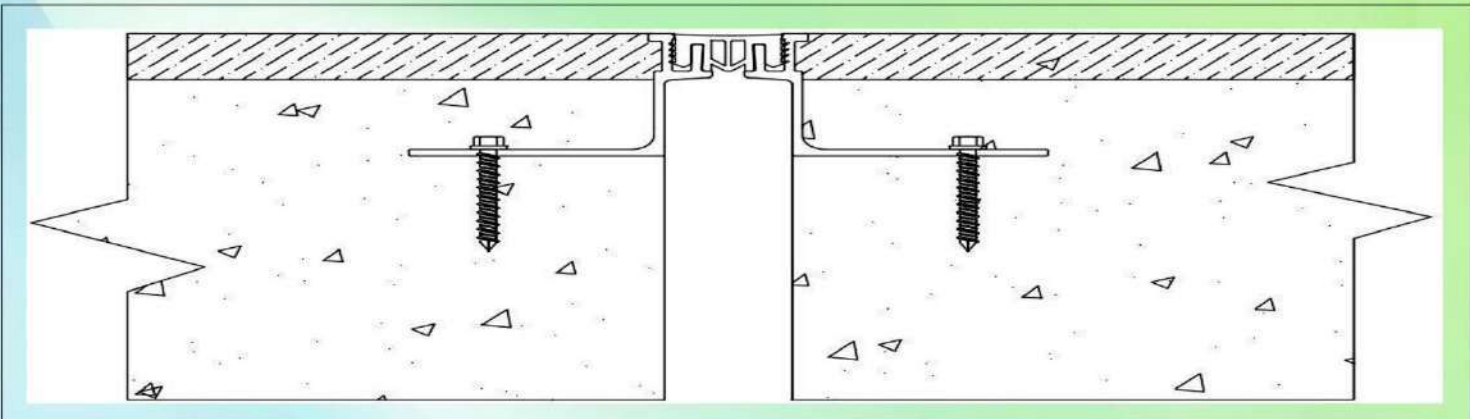
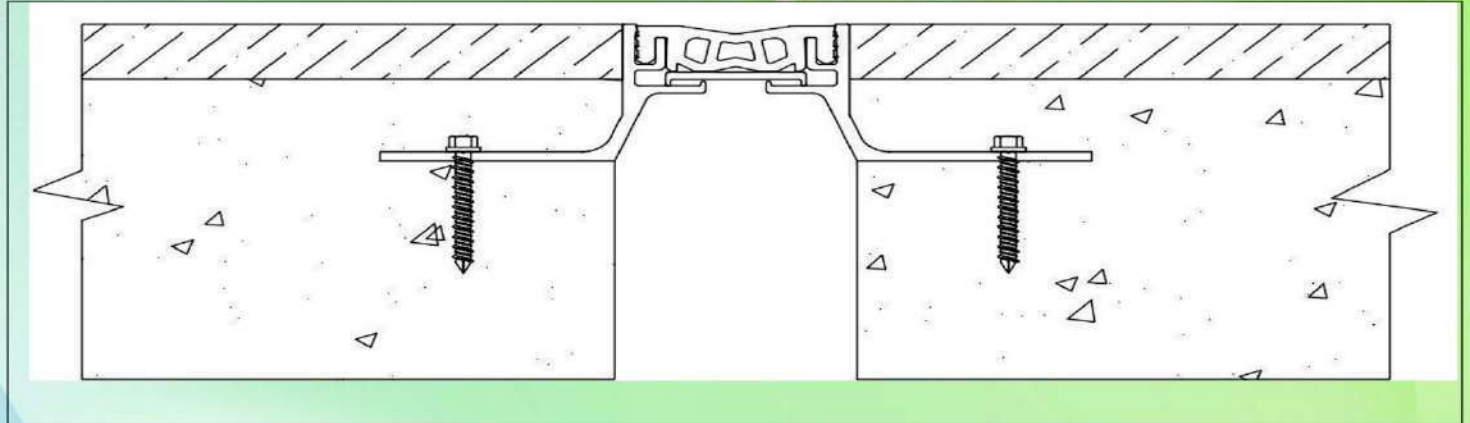

10) Seismic Surface Mount Parking Garage Expansion Joint Cover FSM

Seismic Surface Mount

Parking Garage Expansion Joint Cover

FSM for parking structures is a

Heavy Duty Expansion Joint

,designed to handle damage often caused by dynamic wheel loads,its unique turnbar assembly and bolt housing of the cover shields the assembly from damage caused vehicular traffic.

Material of Cover Plate:Aluminum Alloy/Stainless Steel.

Location:Floor to Floor / Floor to Wall.

Cover Plate Thickness:6.5MM / 8.5MM.

Joint Sizes range from 50mm to 250mm.

Contact us for larger sizes for custom applications.

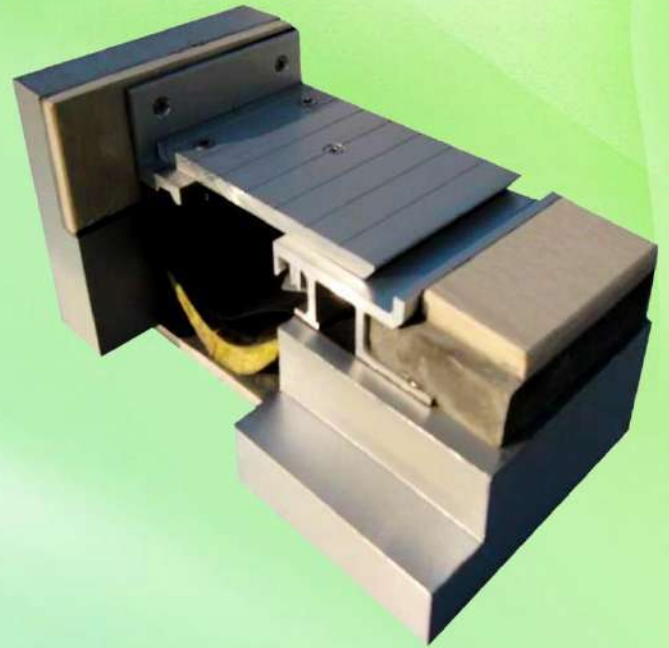
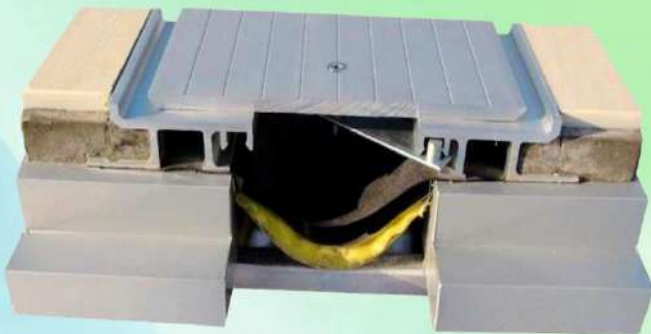



Performance Data

NOTE: Minimum and maximum openings represent movement criteria only

Floor to Floor	Joint Width(W)	50	75	100	125	150	200	250
	Exposed Surface(ES)	173	198	223	248	273	323	373
	Movement Capacity(mm)	70	70	70	70	70	70	70
Floor to Wall	Joint Width(W)	50	75	100	125	150	200	250
	Exposed Surface(ES)	111	136	161	186	211	261	311
	Movement Capacity(mm)	35	35	35	35	35	35	35



Contractors in: **Water Proofing** (Hot, Cold & Acoustic), Buildings, Tunnels, Bridges Off Shores, Swerage System, Base Lining (Environmental & Land Fill Projects) & All Allied Civil Applications

Drawing - Section Details

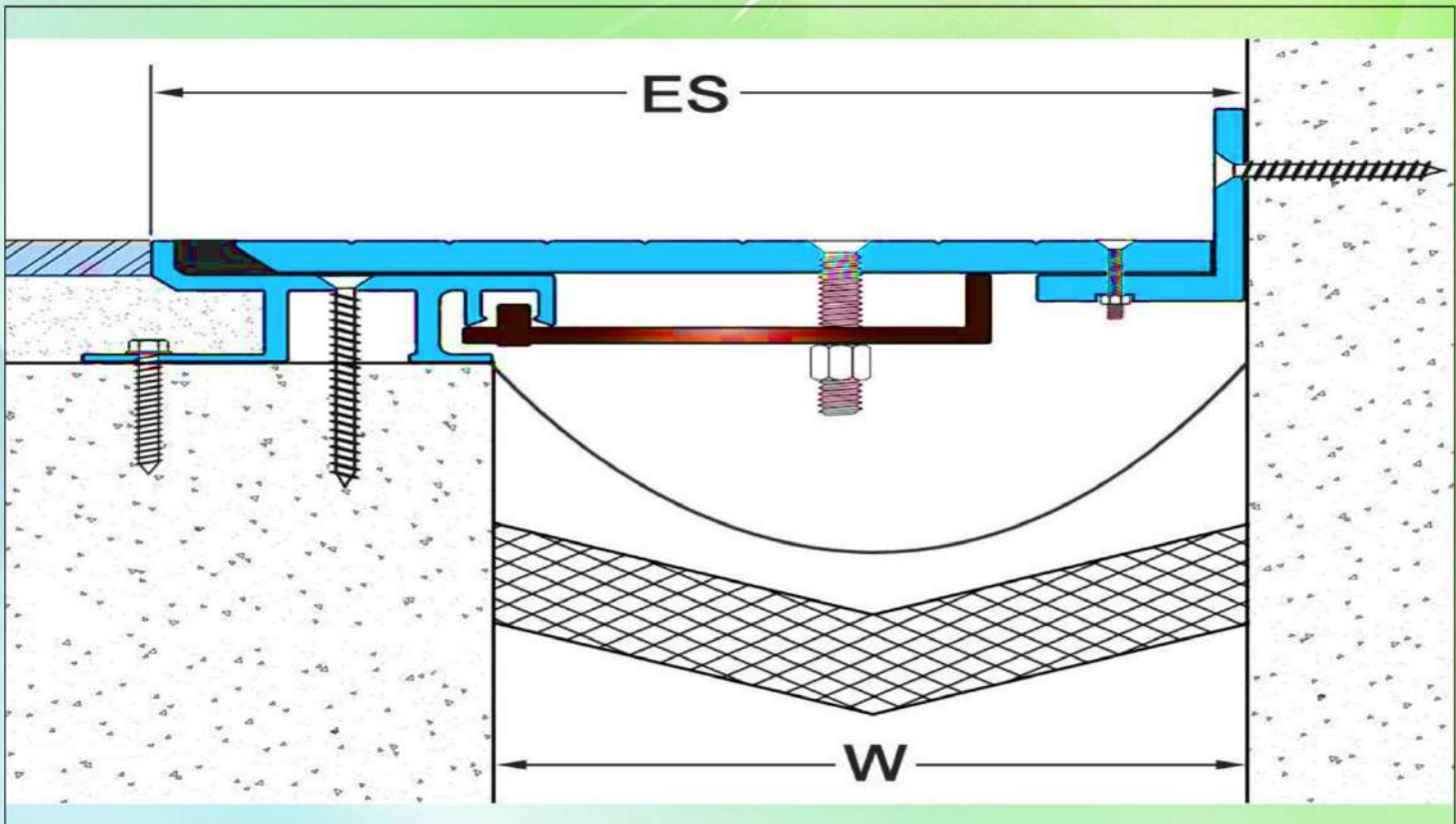
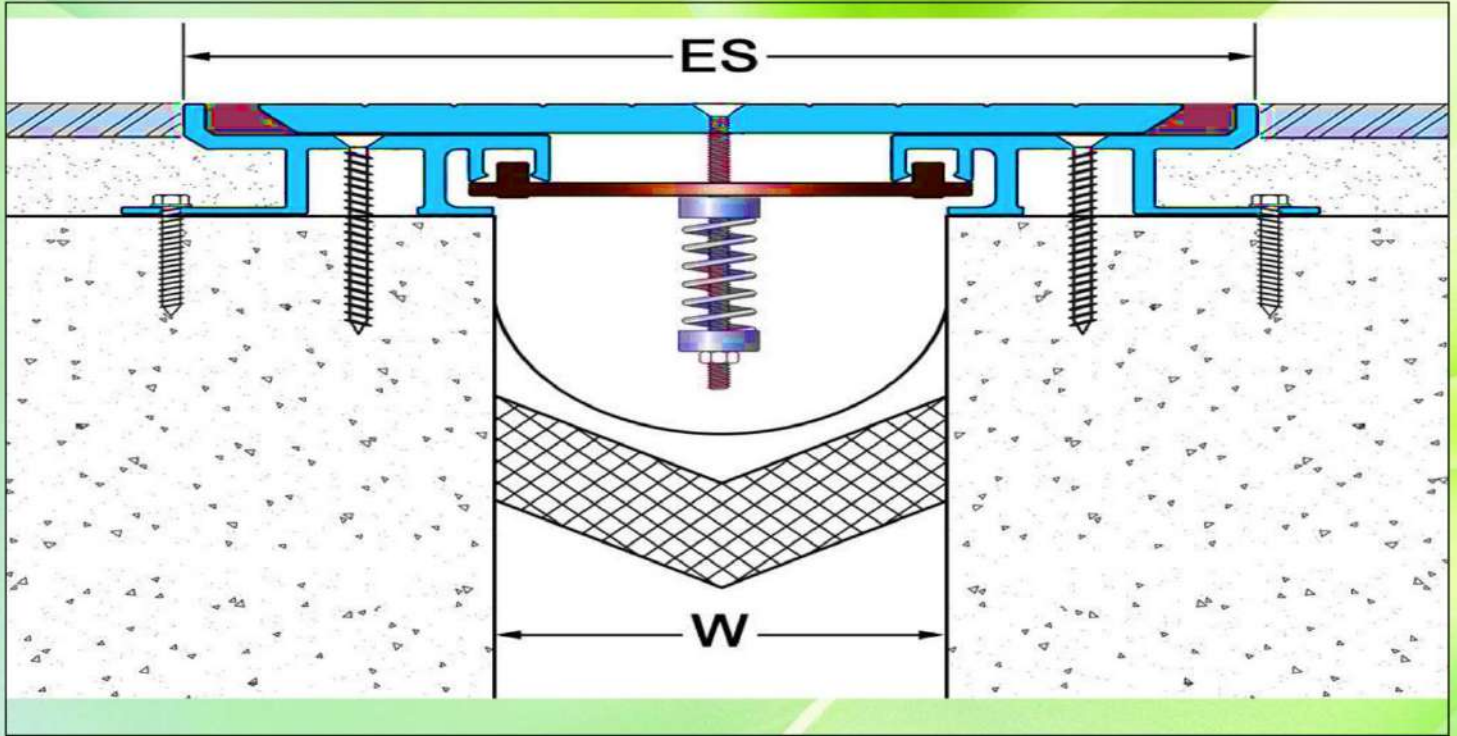



Contractors in: **Water Proofing** (Hot, Cold & Acoustic), Buildings, Tunnels, Bridges Off Shores, Swerage System, Base Lining (Environmental & Land Fill Projects) & All Allied Civil Applications

Maintenance Services

Tile Works





Contractors in: **Water Proofing** (Hot, Cold & Acoustic), Buildings, Tunnels, Bridges Off Shores, Sverage System, Base Lining (Environmental & Land Fill Projects) & All Allied Civil Applications

Plumbing Works





Contractors in: **Water Proofing** (Hot, Cold & Acoustic), Buildings, Tunnels, Bridges Off Shores, Swerage System, Base Lining (Environmental & Land Fill Projects) & All Allied Civil Applications

Paint Works





Contractors in: **Water Proofing** (Hot, Cold & Acoustic), Buildings, Tunnels, Bridges Off Shores, Swerage System, Base Lining (Environmental & Land Fill Projects) & All Allied Civil Applications

Ceiling Works





Contractors in: **Water Proofing** (Hot, Cold & Acoustic), Buildings, Tunnels, Bridges Off Shores, Swerage System, Base Lining (Environmental & Land Fill Projects) & All Allied Civil Applications

Epoxy Coating



Car Parking



Warehouse & Sheds



Metallec Epoxy



Micro-Cement Epoxy

PVC / HDPE Membrane Works

PVC Membrane



HDPE Membrane



Contractors in: **Water Proofing** (Hot, Cold & Acoustic), Buildings, Tunnels, Bridges Off Shores, Sewage System, Base Lining (Environmental & Land Fill Projects) & All Allied Civil Applications

Pile Head treatment

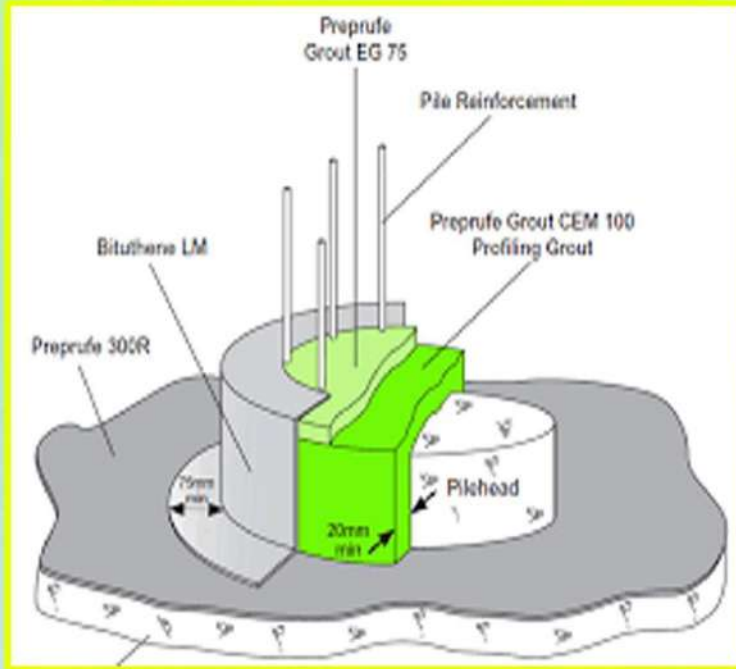



 	 EXPANDED POLYSTYRENE SOLUTIONS	 DERMABIT® WATERPROOFING IND.	 	
 Bayer	 AWAZEL		 La Solución Efectiva	 The Chemical Company
	 	 Injektions- Programm		

Tahir Amin INSULATION CONT. LLC

+971 65469744 +971 50 9677832
info@taic.ae, insulation008@gmail.com

www.taic.ae @taicllc2008
completewaterproofingsolution